

## Valve terminals MPA-L

**FESTO**

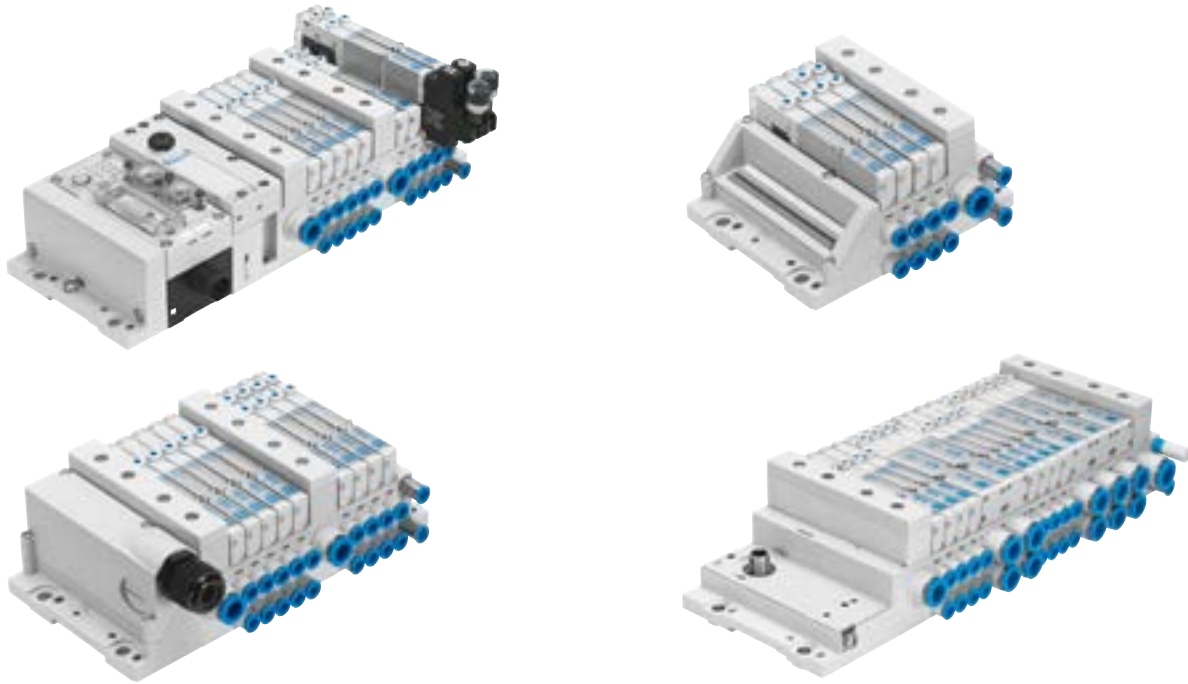

## Characteristics



### Innovative

- Compact high-performance valves in sturdy metal housing
- Flow rates up to 870 l/min
- Wide range of electrical connection options for multi-pin plug: Sub-D, ribbon cable or terminal strip
- Connection to the electrical peripherals CPX with a wide range of communication options
- Connection to the automation system CPX-AP-I
- I-Port/IO-Link interface
- Freely configurable push-in connectors

### Versatile

- Modular system offering a range of configuration options
- Freely extendable system with individual sub-bases and modular tie rods
- Up to 32 solenoid coils
- Conversions and extensions possible at a later date
- Air supply can be extended via additional pressure zones with supply modules
- Wide range of pressures
- $-0.09 \dots +1$  MPa
- Wide range of valve functions

### Reliable

- High output reserves thanks to large pneumatic cross sections and exhausting with high flow rates
- Resilient thanks to high mechanical rigidity
- Lightweight and low-cost polymer components
- Fast troubleshooting thanks to LEDs on the valves
- Easy to service thanks to replaceable valves and electronic modules
- Manual override either non-detenting, detenting or secured against unauthorised activation (covered)
- Durable thanks to tried-and-tested piston spool valves

### Easy to install

- Fast and reliable in-house assembly using individual components or delivered as a ready-to-install and tested unit
- Reduced outlay on selection, ordering, assembly and commissioning
- Secure mounting on wall or H-rail

## Characteristics

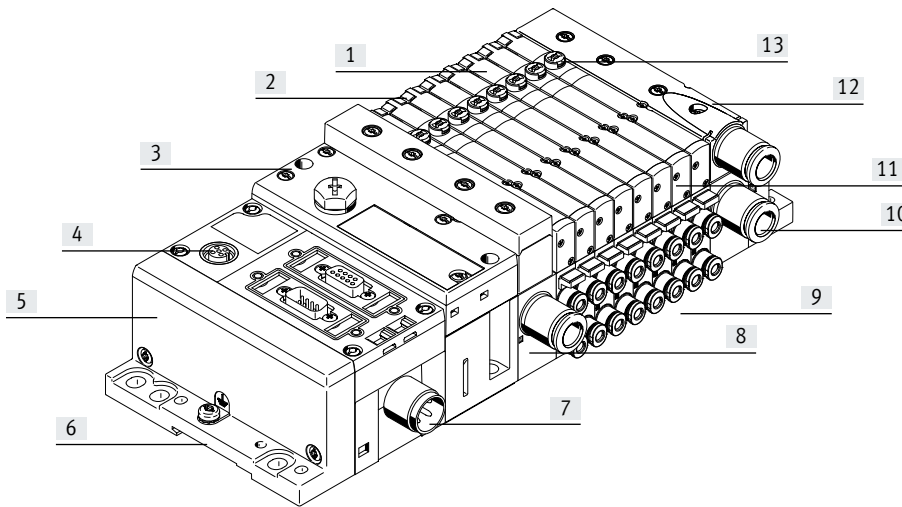

- |  |  |  |   |
|--|--|--|---|
| [1] Width 10 mm, 14 mm and 20 mm   | – CPX-AP-I   | [8] Safe operation:<br>Manual override, non-detenting/<br>detenting or concealed                             | [12] Variable:<br>32 valve positions/32 solenoid<br>coils   |
| [2] Reduced downtimes: LED signal<br>status indicator  | – I-Port interface/IO-Link   | [9] Adaptable:<br>Selector in the end plate for defin-<br>ing the pilot air supply (internal or<br>external) | [13] Modular:<br>Pressure zone creation, additional<br>exhaust and supply ports possi-<br>ble using supply module |
| [3] Pneumatic interface to CPX   | [6] Quick to mount:<br>Directly using screws or on an<br>H-rail  | [10] Practical:<br>Pre-assembled cartridges  |   |
| [4] CPX diagnostic interface   | [7] Reliable:<br>Operating voltage connection,<br>outputs and valves can be<br>disconnected separately | [11] Space-saving:<br>Flat valves and flat plate silencer  |   |
| [5] Straightforward electrical<br>connection<br>– Multi-pin plug connection,<br>fieldbus interface<br>– Control block, CPX |  |  |   |

## Equipment options

## Valve functions

- 5/2-way valve, single solenoid
- 5/2-way valve, double solenoid
- 2x 3/2-way valve, normally open
- 2x 3/2-way valve, normally closed
- 2x 3/2-way valve, 1x normally open,  
1x normally closed
- 5/3-way valve, mid-position  
pressurised
- 5/3-way valve, mid-position closed
- 5/3-way valve, mid-position  
exhausted
- 2x 2/2-way valve, 1x normally  
closed, 1x normally closed,  
reversible
- 2x 2/2-way valve, normally closed
- 1x 3/2-way valve, normally closed,  
external compressed air supply
- 1x 3/2-way valve, normally open,  
external compressed air supply
- Manual pressure regulators

All valves have the same compact di-  
mensions with an overall length of  
107 mm and a height of 55 mm.

## Special characteristics

- |  |   |   |  |
|--|---|---|--|
| <ul style="list-style-type: none"> <li>• Max. 32 valve positions/<br/>max. 32 solenoid coils</li> <li>• Parallel, modular valve linkage</li> </ul> | <ul style="list-style-type: none"> <li>• Electrical manifold module with in-<br/>tegrated holding current reduction</li> <li>• Any compressed air supply<br/>(max. 8 supply modules)</li> </ul> | <ul style="list-style-type: none"> <li>• Creation of pressure zones</li> <li>• Modular, individually extendable tie<br/>rods</li> </ul> | <ul style="list-style-type: none"> <li>• Single valves or combinations of<br/>four valves</li> <li>• Tubing size at each port freely<br/>selectable</li> </ul> |
|--|---|---|--|

## Characteristics

### Valve terminal selection

#### Valve terminal configurator

The appropriate MPA-L valve terminal can be chosen quickly and easily using the online catalogue. This includes a convenient valve terminal configurator, making it much easier to order the right product.

The valve terminals are fully assembled according to your order specification and are individually checked. This reduces assembly and installation time to a minimum.

You can order an MPA-L valve terminal using the order code.

MPA-L ordering system

→ Internet: [mpal](#)

CPX ordering system

→ Internet: [cpx](#)

CPX-AP-I ordering system

→ Internet: [cpx-ap-i](#)

CTEU ordering system

→ Internet: [cteu](#)

Online at: → [www.festo.com](http://www.festo.com)  
2D/3D CAD data

You can request the CAD data for a valve terminal you have configured. To do so, start the product search as described above. Go to the shopping basket and click on the CAD/EPLAN symbol. On the next page, you can generate a 3D preview or request a data format of your choice via e-mail.

### Individual connection

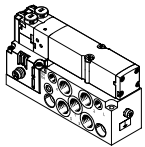

Valves on individual sub-bases can also be used for actuators further away from the valve terminal. The valves are screwed to an individual sub-base made from die-cast aluminium.

The electrical connection is established using a standard 4-pin M8 plug (EN 60947-5-2).

Additional information

→ Internet: [vmpa1](#)

### Individual sub-base assembly

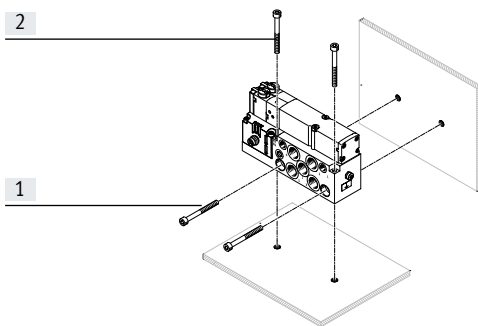

[1] Horizontal mounting holes

[2] Vertical mounting holes

The individual sub-base for wall mounting is designed for integration into a system or machine. It can be mounted horizontally or vertically.

### Multi-pin plug connection

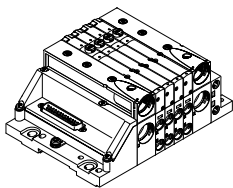

The signals are transmitted from the controller to the valve terminal via a pre-assembled or self-assembled multi-wire cable to the multi-pin plug connection, which substantially reduces installation time.

The valve terminal can be equipped with max. 32 solenoid coils. This corresponds to 2 to 32 valves.

Variants

- Sub-D connection
  - Pre-assembled multi-pin cable
  - Multi-pin cable for self-assembly
- Ribbon cable connection
- Terminal strip connection

## Characteristics

### Fieldbus interface via the CPX system

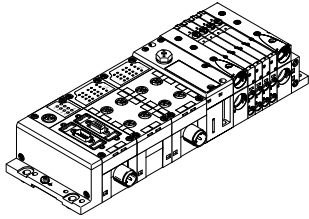

An integrated bus node manages communication with a higher-order PLC. This enables space-saving pneumatic and electronic solutions to be implemented. Valve terminals with fieldbus interfaces can be configured with up to 32 sub-bases.

The CPX terminal also enables the integration of digital and analogue electrical inputs and outputs, pressure sensors and controllers for pneumatic or electric positioning axes. A detailed description of the extensive functionality can be found in the documentation for the CPX terminal  
→ Internet: [cpx](#)

Fieldbus protocols/CPX variants:

- PROFIBUS DP
- PROFINET
- INTERBUS
- DeviceNet
- CANopen
- CC-Link
- EtherNet/IP
- Front End Controller
- Remote I/O
- Modbus/TCP
- EtherCAT
- POWERLINK
- Sercos III

### Control block connection via the CPX system

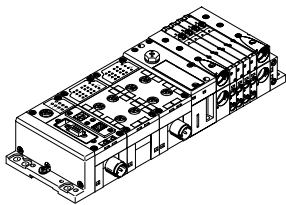

Controllers integrated in the Festo valve terminals enable the construction of stand-alone control units to IP65, without control cabinets.

In the slave operating mode, these valve terminals can be used for intelligent preprocessing and are therefore ideal modules for designing decentralised intelligence.

In the master operating mode, terminal groups can be designed with many options and functions that can autonomously control a medium-sized machine/system.

### Fieldbus interface via the automation system CPX-AP-I

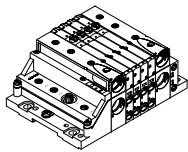

CPX-AP-I is a flexible, decentralised, compact and lightweight automation system with high degree of protection IP65/IP67. An automation system CPX-AP-I consists of a bus interface and at least one other module. System communication between the modules takes place via connecting cables.

The process data is exchanged cyclically. The following module types are available:

- Bus interface
- Input modules
- Input/output modules
- Interface for valve terminal

Fieldbus protocols:

- PROFINET
- PROFIBUS
- EtherNet/IP
- EtherCAT

### Fieldbus interface via the CTEU system

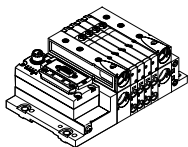

A bus node directly mounted on the I-Port interface manages communication with a higher-order PLC. Valve terminals with I-Port interface can be configured with up to 32 sub-bases.

A detailed description of the extensive functionality can be found in the documentation for the CTEU fieldbus modules/CTEL installation system  
→ Internet: [cteu](#)

Fieldbus protocols:

- PROFIBUS DP
- DeviceNet
- CANopen
- CC-Link
- EtherCAT

### I-Port interface/IO-Link

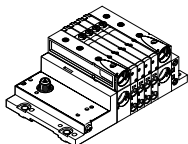

I-Port/IO-Link consists of a central master and the I-Port interface/IO-Link devices connected via special connecting cables. This permits a decentralised layout of the devices. The connection type corresponds to a star topology.

In other words, only one module or valve terminal can be connected to each I-Port. The I-Port interface from Festo is based on IO-Link and is compatible with IO-Link in certain areas.

As well as communication, the I-Port interfaces also handle the power supply for the connected devices. The maximum length of a string is 20 m.

## Peripherals overview

### Modular pneumatic components

The modular design of the MPA-L facilitates maximum flexibility right from the planning stage and offers maximum ease of servicing during operation. The system consists of sub-bases and valves.

The sub-bases form the support system for the valves. They contain the ducts for supplying compressed air to and exhausting from the valve terminal as well as the working ports for the pneumatic drives for each valve.

The sub-bases are joined together via a tie rod system. This consists of a threaded rod, threaded sleeve and screw. The threaded rod/sleeve combination is selected as appropriate for the chosen number of individual sub-bases.

A valve terminal can be easily extended by adding individual sub-bases or supply modules. This is done by inserting suitable tie rod extenders between the threaded rod and the sleeve. This ensures that the valve terminal can be rapidly and reliably extended.

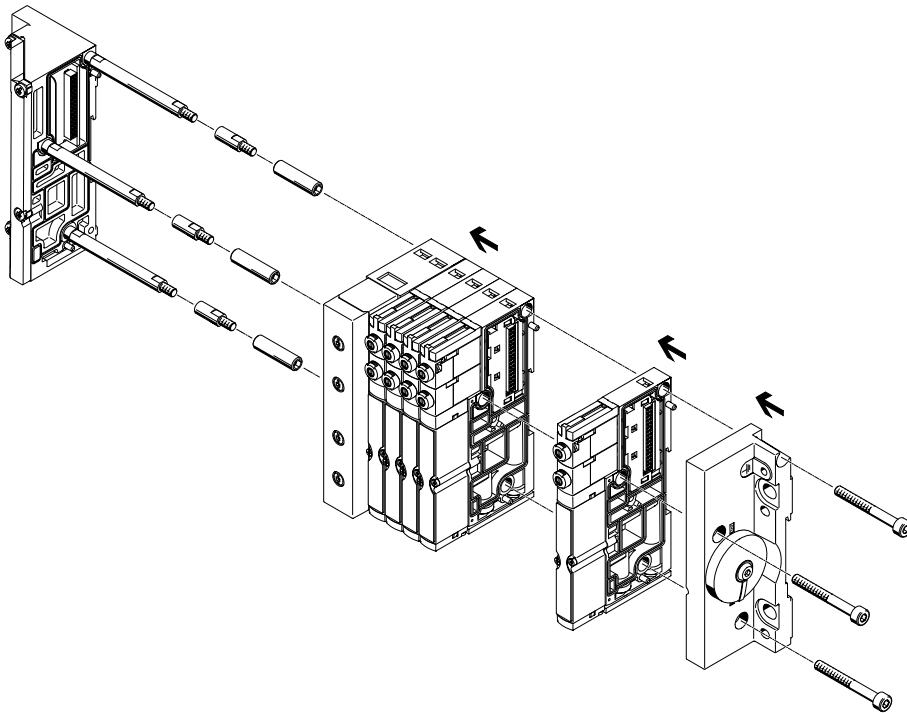

#### Note

The tie rod system for the valve terminal MPA-L consists of at least four sub-bases or two sub-bases and one supply module. Shorter valve terminals with at least 2 valve positions can be configured without a sleeve.

### Modular electrical peripherals

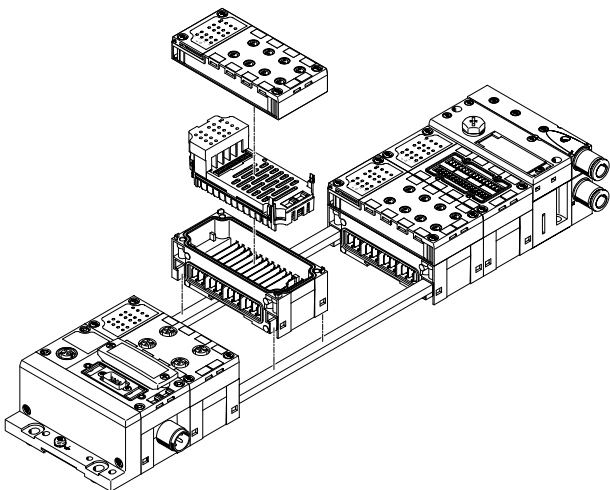

The mechanical connection between the CPX modules is established using tie rods. Two screws in the end plates are all that are needed to assemble the entire unit.

The tie rod ensures that the unit has a high mechanical load bearing capacity and is therefore the mechanical backbone of the CPX terminal.

The open design allows interlinking blocks to be replaced in assembled state.

The tie rod extension kit allows an extra module to be added to the CPX terminal.

The input/output modules, manifold blocks, bus node or control block of the CPX system are fastened to the interlinking blocks using 4 screws and can be exchanged or modified in nearly any way.

## Peripherals overview

### Individual sub-base

Ordering:

- Using individual part numbers

Individual sub-bases can be equipped with any valve (VMPA... of the corresponding width).

The electrical connection is established using a standard 4-pin M8 plug (EN 60947-5-2).

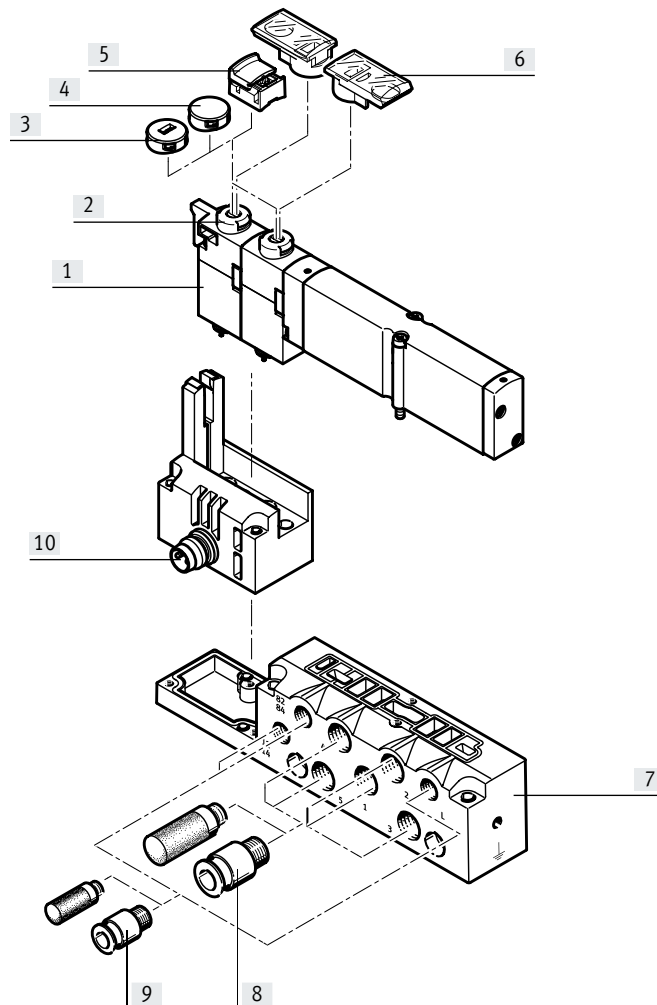

Designation	Brief description	→ Page/Internet
[1] Solenoid valve	Width 10 mm, 14 mm, 20 mm	VMPA1
[2] Manual override (MO)	Non-detenting/detenting by turning, per solenoid coil	VMPA1
[3] Cover cap	MO non-detenting only once cover cap fitted	VMPA1
[4] Cover cap	MO blocked once cover cap fitted	VMPA1
[5] Cover cap	MO detenting and can be operated without accessories once cover cap fitted	VMPA1
[6] Identification holder	Can be pushed onto manual override	VMPA1
[7] Sub-base	For individual valve VMPA...	VMPA1
[8] Fittings, silencers or blanking plugs	For working ports (2, 4) and air supply/exhaust ports (1, 3, 5)	VMPA1
[9] Fittings and/or silencers	For pilot air supply/pilot exhaust air (12/14, 82/84) and pressure compensation	VMPA1
[10] Electrical connection M8	4-pin	VMPA1

## Peripherals overview

### Valve terminal pneumatics

The sub-bases are available individually with one valve position or with four valve positions.

The electrical manifold modules are available for:

- 1 or 4 single solenoid valves
- 1 or 4 double solenoid valves

• Double solenoid valve positions can be equipped with any valve or a cover plate.

• Single solenoid valve positions can only be equipped with single solenoid valves or a cover plate.

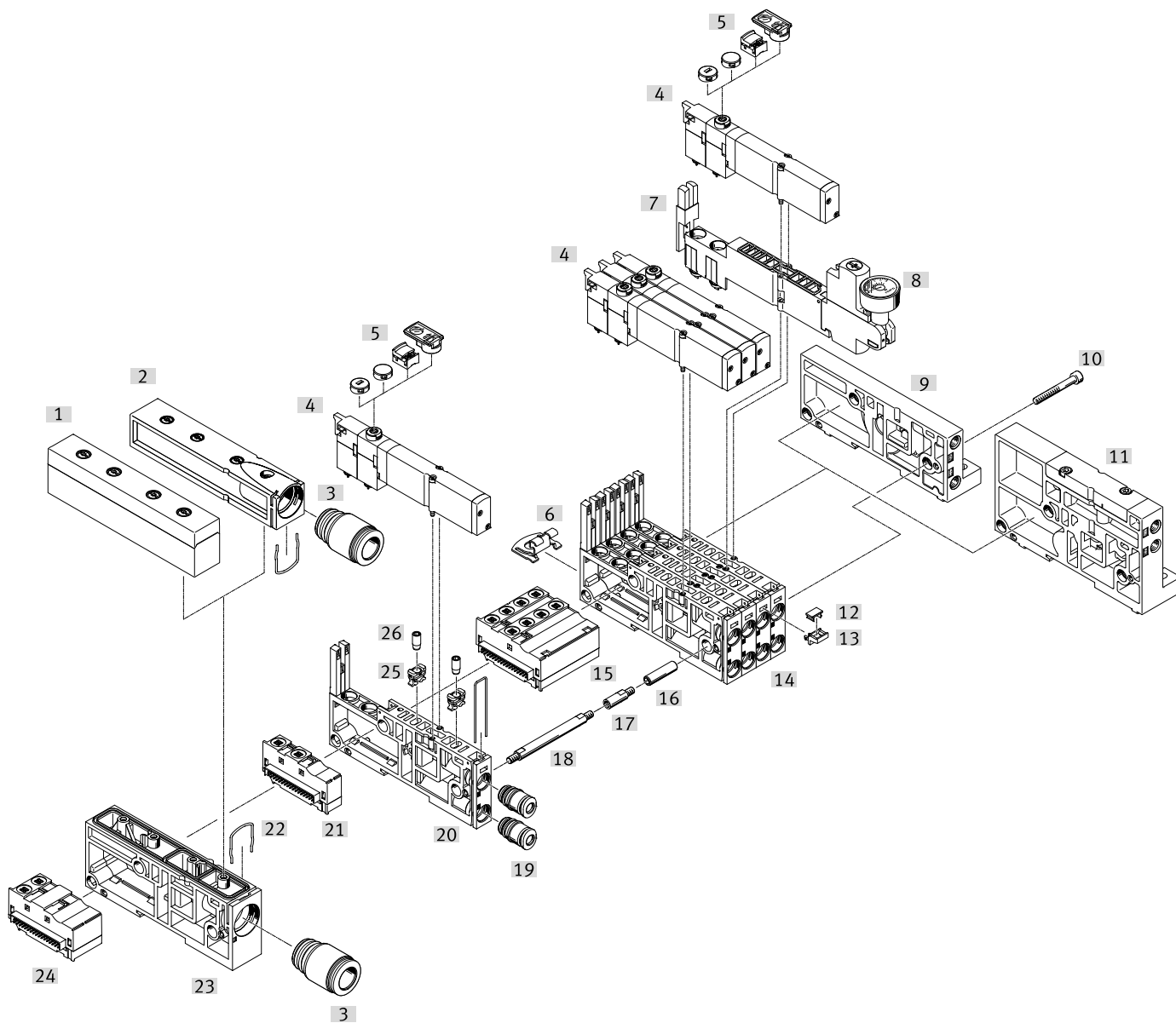



## Peripherals overview

Valve terminal pneumatics			
Designation	Brief description	→ Page/Internet	
[1]	Plate	Exhaust plate as flat plate silencer	65
[2]	Plate	Exhaust plate for ducted exhaust air	65
[3]	Cartridge	For air supply and exhaust ports	68
[4]	Solenoid valve	Single solenoid	53
[5]	Cover cap for manual override	Conversion from detenting/non-detenting to non-detenting or detenting or concealed or identification holder	64
[6]	Mounting	Mounting bracket for wall mounting	64
[7]	Regulator plate	Vertical stacking (pressure regulator, vertical pressure shut-off plate, vertical pressure supply plate)	54, 61
[8]	Pressure gauge	Can be optionally mounted on a pressure regulator plate	54
[9]	Right-hand end plate, low	End plate with pilot air selector, with ports 12/14, 82/84	66
[10]	Screw	Tie rod system, connects the sub-bases	63
[11]	Right-hand end plate, high	End plate with pilot air selector, with ports 1, 3, 5, 12/14, 82/84	66
[12]	Inscription label	6 x 10 mm	64
[13]	Retainer for inscription label	-	64
[14]	Sub-base	Four individual sub-bases screwed together to form one unit	56
[15]	Electrical manifold module, 4-way	Electrical manifold module for combination of four sub-bases, single solenoid/double solenoid	56
[16]	Sleeve	Tie rod system, connects the sub-bases	63
[17]	Tie rod extender	For subsequent modular extension of the valve terminal	63
[18]	Tie rod	Threaded rod, clamps the sub-bases between the end plates	63
[19]	Cartridge	For working ports	68
[20]	Sub-base, individual	Sub-base with one valve position	56
[21]	Electrical manifold module	Electrical manifold module for one sub-base, single solenoid/double solenoid	56
[22]	Clamp strap for cartridge	-	-
[23]	Supply module	For compressed air supply/exhaust air	65
[24]	Electrical manifold module	Electrical manifold module for supply module, signals are passed through	56
[25]	Retainer for restrictor	Required to install the fixed flow restrictor	55
[26]	Flow restrictor	Fixed flow restrictor for installation in duct 3 or 5 of the sub-base	55

## Peripherals overview

### Valve terminal with multi-pin plug connection

Order code:

- 34P-...

MPA-L valve terminals with multi-pin plug connection can be expanded by up to 32 solenoid coils/valve positions.

The multi-pin plug connection is removable and designed as a 9, 25 or 44-pin Sub-D connection. The multi-pin plug connection can alternatively be ordered as a terminal strip (33-pin) or ribbon cable connection (40-pin).

The Sub-D multi-pin plug connection, 25 and 44-pin, is available with degree of protection IP40 and IP67 or with multi-pin cover cap, without connecting cable, with a choice of cable outlet to the side or front.

Sub-D multi-pin plug connection, 25 and 44-pin, with multi-pin cover cap with pre-assembled cable:

- 2.5 m
- 5 m
- 10 m
- Variable, up to 30 m

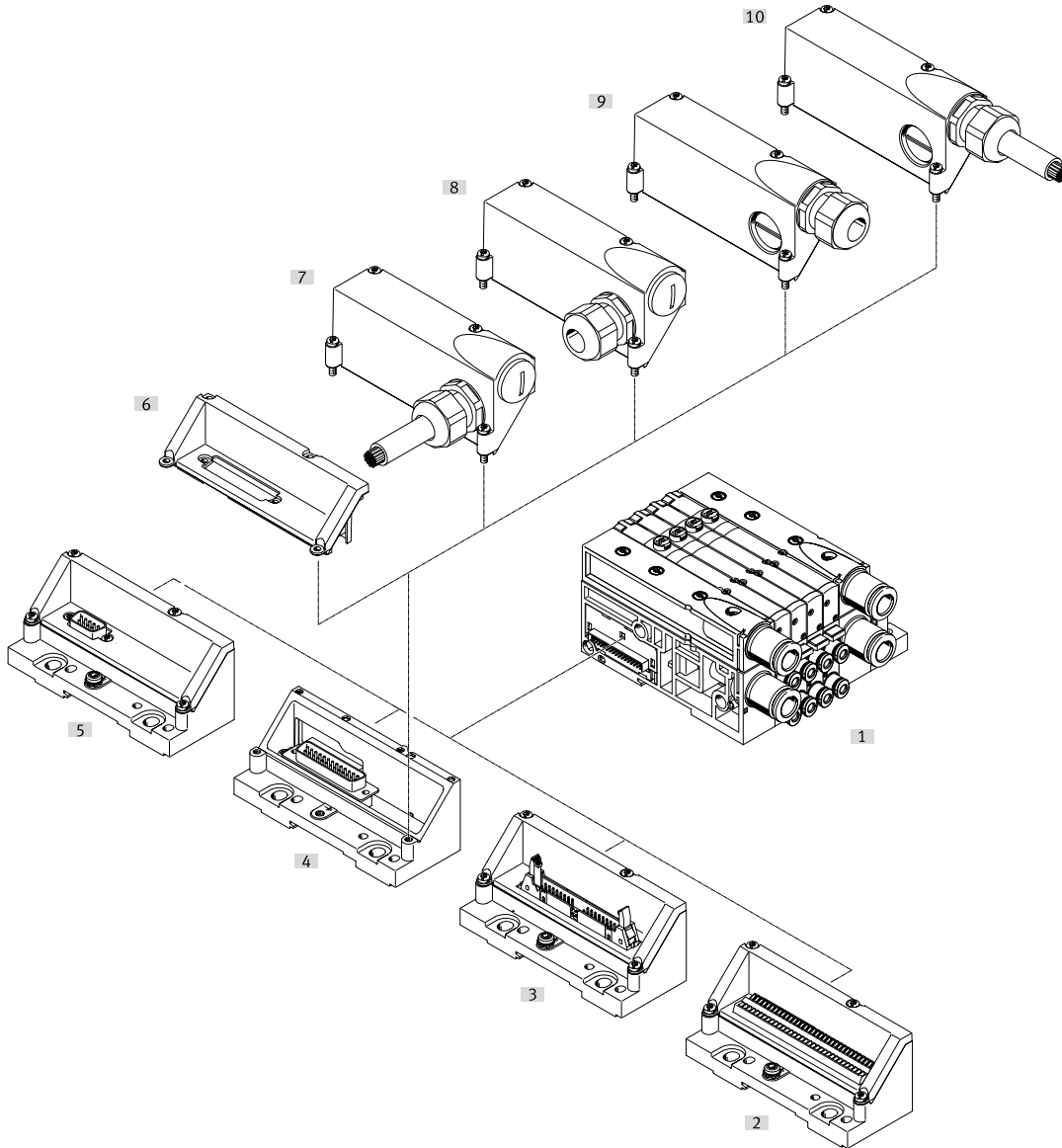

Designation	Brief description	→ Page/Internet
[1] Valve terminal	Pneumatic part of the valve terminal	8
[2] Multi-pin plug connection	Terminal strip, 33-pin, IP40	66
[3] Multi-pin plug connection	For ribbon cable, 40-pin, IP40	66
[4] Multi-pin plug connection	Sub-D, 25-pin	66
[5] Multi-pin plug connection	Sub-D, 9-pin, IP40	66
[6] Multi-pin plug connection	Covering (with intermediate without hood)	-
[7] Connecting cable	With hood, pre-assembled, connection on side, IP67	67
[8] Hood	For self-assembly, connection on side, IP67	67
[9] Hood	For self-assembly, connection on front, IP67	67
[10] Connecting cable	With hood, pre-assembled, connection on front, IP67	67

## Peripherals overview

### Valve terminal with fieldbus interface, control block (electrical peripherals CPX)

Order code:

- 34P-... for the pneumatic components
- 50E-... for the electrical peripherals

Valve terminals with CPX interface can be expanded by up to 32 solenoid coils/valve positions.

Up to 32 valve positions can be equipped in combination with single solenoid valves; the maximum number of valve positions is reduced to 16 if only double solenoid valves are used. The maximum number of addresses is set in the range 4 ... 32 solenoid coils via a selector switch.

This enables extensions to be pre-assigned in a control program and called up by manual settings.

Each valve position can be equipped with any valve or a cover plate. The rules for CPX apply to the equipment that can be used with the electrical peripherals CPX.

In general:

- Digital inputs/outputs

- Analogue inputs/outputs
- Parameterisation of inputs and outputs
- Integrated convenient diagnostics
- Preventive maintenance concepts

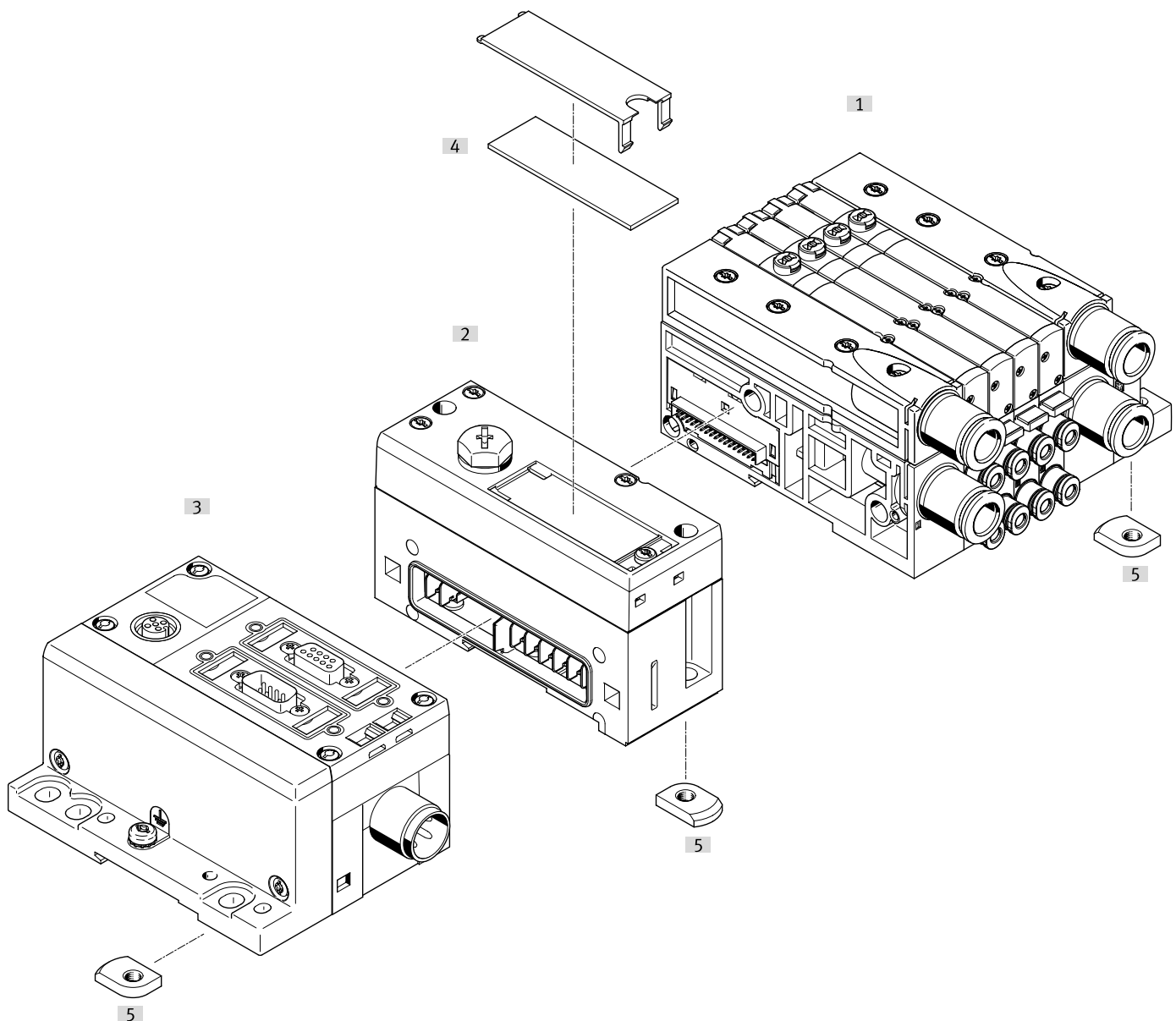

Designation	Brief description	→ Page/Internet
[1] Valve terminal	Pneumatic part of the valve terminal	8
[2] Left-hand end plate	Pneumatic interface for CPX terminal	66
[3] CPX modules	Bus node, control block, input and output modules	cpx
[4] Inscription label	Large, for left-hand end plate/pneumatic interface for CPX terminal	-
[5] H-rail mounting	-	64

## Peripherals overview

### Valve terminal with interface to automation system CPX-AP-I

Order code:

- 34P... for the pneumatic components
- CPX-AP-I components are to be ordered individually

Valve terminals with CPX-AP-I interface can be expanded by up to 32 solenoid coils/valve positions.

Up to 32 valve positions can be equipped in combination with single solenoid valves.

The maximum number of valve positions is reduced to 16 if only double solenoid valves are used.

Each valve position can be equipped with any valve or a cover plate.

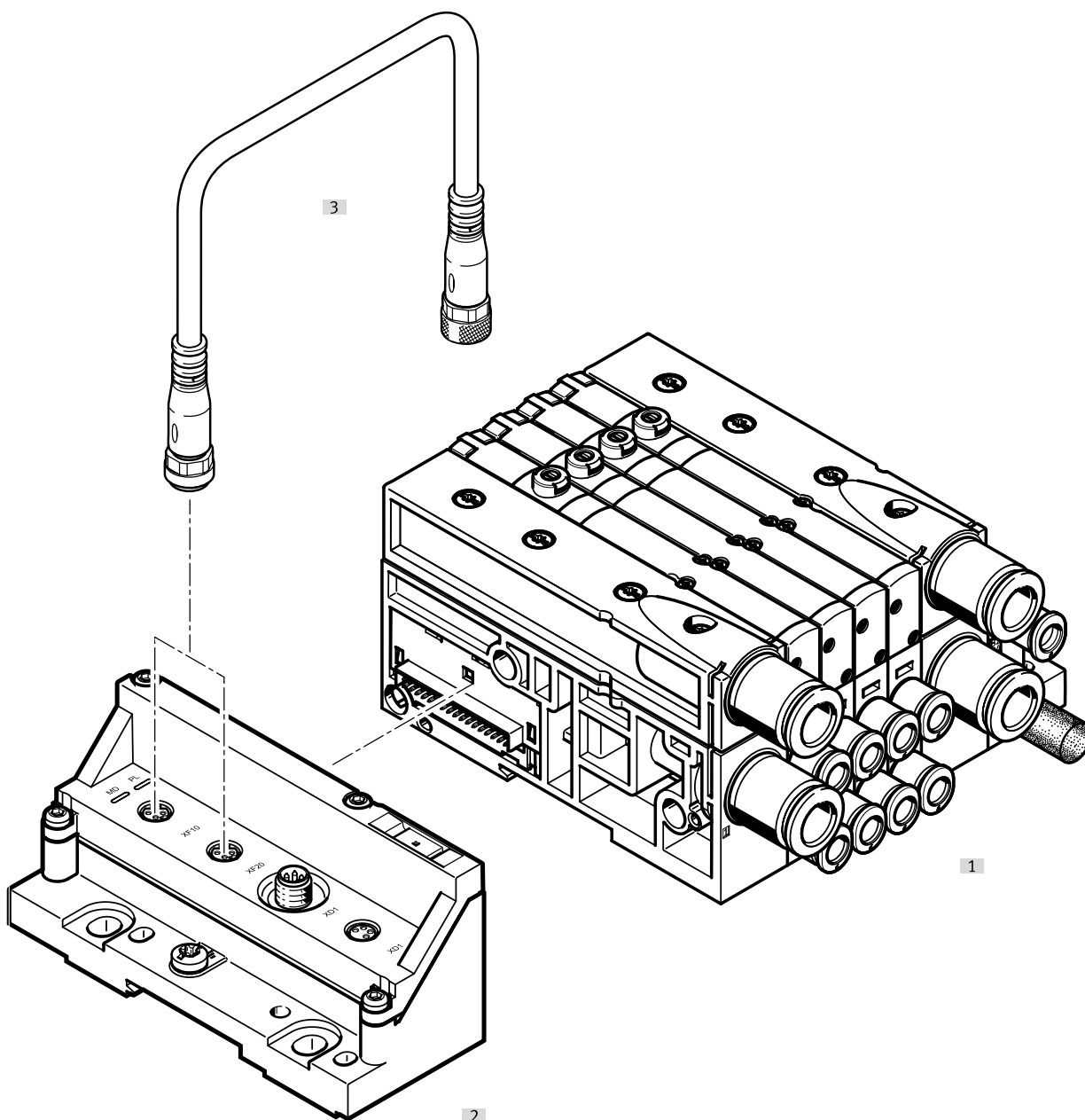

Designation	Brief description	→ Page/Internet
[1] Valve terminal	Pneumatic part of the valve terminal	8
[2] Left-hand end plate	End plate with interface to automation system CPX-API and with interface for power supply	66
[3] Connecting cable	Between two CPX-AP-I modules	cpx-ap-i

## Peripherals overview

### Valve terminal with I-Port interface/IO-Link (and bus node)

Order code:

- 34P-... for the pneumatic components
- CTEU-... for the bus node

Valve terminals with I-Port interface/IO-Link can be expanded by up to 32 solenoid coils/valve positions. Up to 32 valve positions can be equipped in combination with single solenoid valves.

The maximum number of valve positions is reduced to 16 if only double solenoid valves are used.

Each valve position can be equipped with any valve or a cover plate.

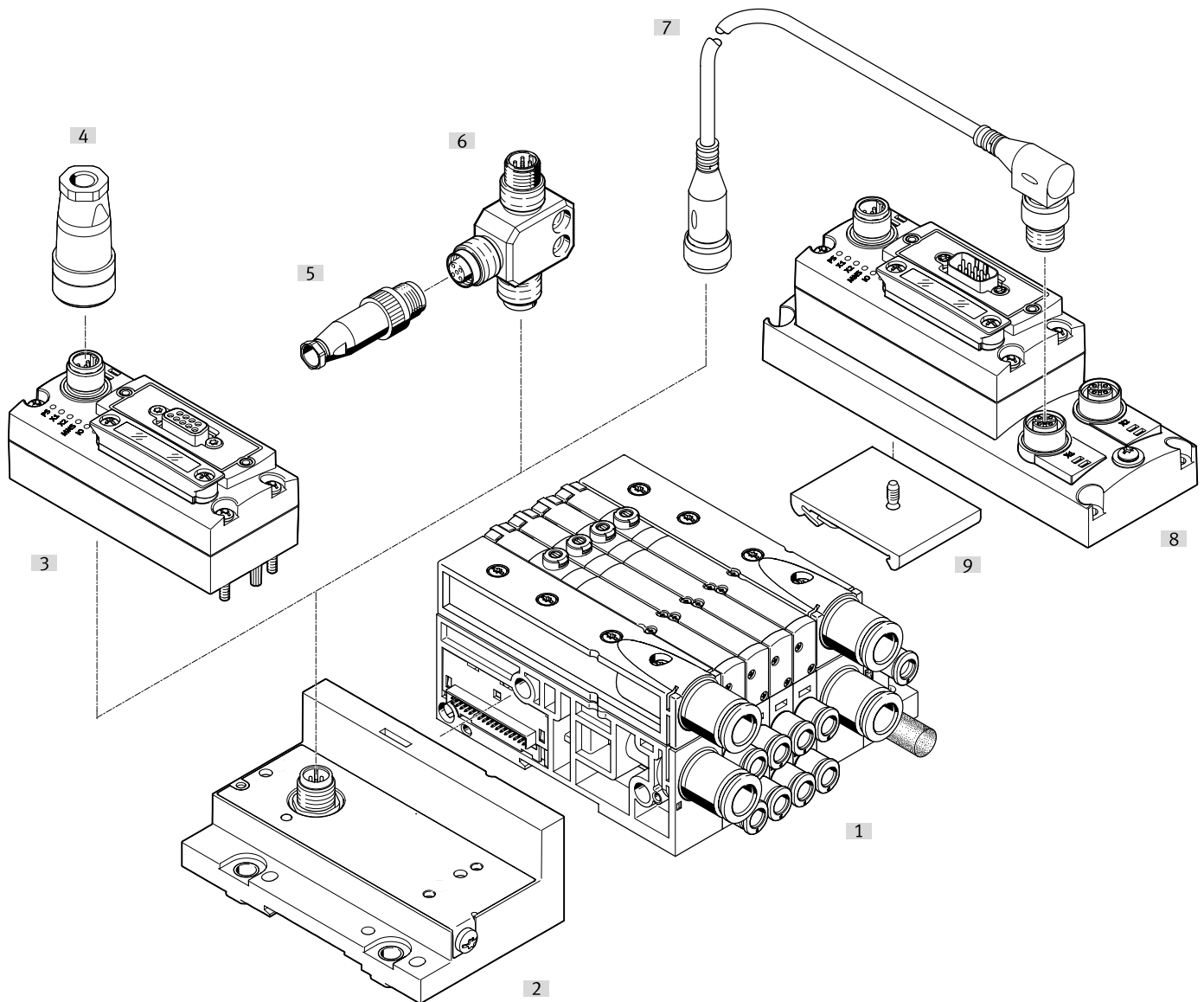

Designation	Brief description	→ Page/Internet
[1] Valve terminal	Pneumatic part of the valve terminal	8
[2] Left-hand end plate	End plate with I-Port interface/IO-Link	66
[3] Bus node CTEU	Bus node	cteu
[4] Socket	For power supply	ntsd
[5] Plug	For I-Port interface/IO-Link	sea
[6] T adapter	For I-Port interface/IO-Link	fb-ta
[7] Connecting cable	Between two I-Port interfaces	nebv
[8] Electrical connection block	With bus node for connecting two devices with I-Port interfaces	cteu
[9] H-rail mounting	For electrical connection block	cteu

## Characteristics – Pneumatic components

### Sub-base valve

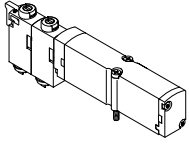

MPA-L offers a comprehensive range of valve functions. The valves are equipped with a piston spool and patented sealing system to facilitate efficient sealing, a broad pressure range and a long service life. Polymer poppet valves are available as an alternative for size 10 mm. All valves have pneumatic pilot control for optimising performance.

Compressed air is supplied via a pilot air supply port. Sub-base valves can be replaced quickly since the tubing connections remain on the sub-base. This design is also very flat.

Whatever valve function is required, there are sub-base valves with one solenoid coil (single solenoid) or with two solenoid coils (double solenoid or two single solenoid valves in one housing).

### Design

#### Valve replacement

The valves are attached to the sub-base using two screws,

which means that they can be easily replaced. The mechanical sturdiness of the sub-base guarantees good long-term sealing.

#### Extension

Cover plates can be replaced by valves at a later date. The dimensions, mounting points and existing pneumatic installations remain unchanged during this process.

The valve code (e.g. M, J, N, NS, NU) is located on the front of the valve beneath the manual override.

#### Note

A filter must be installed upstream of valves operated in vacuum mode. This prevents any foreign matter in the intake air getting into the valve (e.g. when operating a suction cup with connector).

### 5/2-way valve

#### Circuit symbol

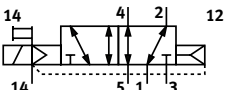
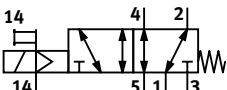
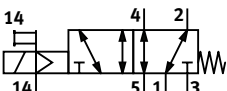
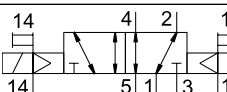
Circuit symbol	Code	Description
	Position function 1-32: M	<ul style="list-style-type: none"> <li>• Single solenoid</li> <li>• Pneumatic spring return</li> <li>• Reversible</li> <li>• Operating pressure –0.09 ... +1 MPa</li> <li>• Available in width of 10 mm, 14 mm and 20 mm</li> </ul>
	Position function 1-32: MS	<ul style="list-style-type: none"> <li>• Single solenoid</li> <li>• Mechanical spring return</li> <li>• Reversible</li> <li>• Operating pressure –0.09 ... +0.8 MPa</li> <li>• Available in width of 10 mm, 14 mm and 20 mm</li> </ul>
	Position function 1-32: MU	<ul style="list-style-type: none"> <li>• Single solenoid</li> <li>• Polymer poppet valve</li> <li>• Mechanical spring return</li> <li>• Reversible</li> <li>• Operating pressure –0.09 ... +1 MPa</li> <li>• Available in width of 10 mm</li> <li>• 5/2-way function is achieved using two mechanically separate switching elements</li> </ul>
	Position function 1-32: J	<ul style="list-style-type: none"> <li>• Double solenoid</li> <li>• Reversible</li> <li>• Operating pressure –0.09 ... +1 MPa</li> <li>• Available in width of 10 mm, 14 mm and 20 mm</li> </ul>

## Characteristics – Pneumatic components

2x 3/2-way valve Circuit symbol	Code	Description
	Position function 1-32: N	<ul style="list-style-type: none"> <li>• Single solenoid</li> <li>• Normally open</li> <li>• Pneumatic spring return</li> <li>• Operating pressure 0.3 ... 1 MPa</li> <li>• Available in width of 10 mm, 14 mm and 20 mm</li> </ul>
	Position function 1-32: NS	<ul style="list-style-type: none"> <li>• Single solenoid</li> <li>• Normally open</li> <li>• Mechanical spring return</li> <li>• Reversible</li> <li>• Operating pressure -0.09 ... +0.8 MPa</li> <li>• Available in width of 10 mm, 14 mm and 20 mm</li> </ul>
	Position function 1-32: NU	<ul style="list-style-type: none"> <li>• Single solenoid</li> <li>• Polymer poppet valve</li> <li>• Normally open</li> <li>• Mechanical spring return</li> <li>• Reversible</li> <li>• Operating pressure -0.09 ... +1 MPa</li> <li>• Available in width of 10 mm</li> </ul>
	Position function 1-32: K	<ul style="list-style-type: none"> <li>• Single solenoid</li> <li>• Normally closed</li> <li>• Pneumatic spring return</li> <li>• Operating pressure 0.3 ... 1 MPa</li> <li>• Available in width of 10 mm, 14 mm and 20 mm</li> </ul>
	Position function 1-32: KS	<ul style="list-style-type: none"> <li>• Single solenoid</li> <li>• Normally closed</li> <li>• Mechanical spring return</li> <li>• Reversible</li> <li>• Operating pressure -0.09 ... +0.8 MPa</li> <li>• Available in width of 10 mm, 14 mm and 20 mm</li> </ul>
	Position function 1-32: KU	<ul style="list-style-type: none"> <li>• Single solenoid</li> <li>• Polymer poppet valve</li> <li>• Normally closed</li> <li>• Mechanical spring return</li> <li>• Reversible</li> <li>• Operating pressure -0.09 ... +1 MPa</li> <li>• Available in width of 10 mm</li> </ul>
	Position function 1-32: H	<ul style="list-style-type: none"> <li>• Single solenoid</li> <li>• Normal position <ul style="list-style-type: none"> <li>- 1x closed</li> <li>- 1x open</li> </ul> </li> <li>• Pneumatic spring return</li> <li>• Operating pressure 0.3 ... 1 MPa</li> <li>• Available in width of 10 mm, 14 mm and 20 mm</li> </ul>
	Position function 1-32: HS	<ul style="list-style-type: none"> <li>• Single solenoid</li> <li>• Normal position <ul style="list-style-type: none"> <li>- 1x closed</li> <li>- 1x open</li> </ul> </li> <li>• Mechanical spring return</li> <li>• Reversible</li> <li>• Operating pressure -0.09 ... +0.8 MPa</li> <li>• Available in width of 10 mm, 14 mm and 20 mm</li> </ul>
	Position function 1-32: HU	<ul style="list-style-type: none"> <li>• Single solenoid</li> <li>• Polymer poppet valve</li> <li>• Normal position <ul style="list-style-type: none"> <li>- 1x closed</li> <li>- 1x open</li> </ul> </li> <li>• Mechanical spring return</li> <li>• Reversible</li> <li>• Operating pressure -0.09 ... +1 MPa</li> <li>• Available in width of 10 mm</li> </ul>

Characteristics – Pneumatic components

5/3-way valve		
Circuit symbol	Code	Description
	Position function 1-32: B	<ul style="list-style-type: none"> <li>• Mid-position pressurised<sup>1)</sup></li> <li>• Mechanical spring return</li> <li>• Reversible</li> <li>• Operating pressure –0.09 ... +1 MPa</li> <li>• Available in width of 10 mm, 14 mm and 20 mm</li> </ul>
	Position function 1-32: G	<ul style="list-style-type: none"> <li>• Mid-position closed<sup>1)</sup></li> <li>• Mechanical spring return</li> <li>• Reversible</li> <li>• Operating pressure –0.09 ... +1 MPa</li> <li>• Available in width of 10 mm, 14 mm and 20 mm</li> </ul>
	Position function 1-32: E	<ul style="list-style-type: none"> <li>• Mid-position exhausted<sup>1)</sup></li> <li>• Mechanical spring return</li> <li>• Reversible</li> <li>• Operating pressure –0.09 ... +1 MPa</li> <li>• Available in width of 10 mm, 14 mm and 20 mm</li> </ul>

1) If neither solenoid coil is energised, the valve is moved to its mid-position by spring force.  
If both coils are energised at the same time, the valve remains in the previously assumed switching position.

3/2-way valve		
Circuit symbol	Code	Description
	Position function 1-32: W	<ul style="list-style-type: none"> <li>• Single solenoid</li> <li>• Normally open</li> <li>• External compressed air supply</li> <li>• Pneumatic spring return</li> <li>• Reversible</li> <li>• Operating pressure –0.09 ... +1 MPa</li> <li>• Available in width of 10 mm, 14 mm and 20 mm</li> </ul> <p>Compressed air (–0.9 ... +10 bar) supplied at working port 2 can be switched with both internal and external pilot air supply.</p>
	Position function 1-32: X	<ul style="list-style-type: none"> <li>• Single solenoid</li> <li>• Normally closed</li> <li>• External compressed air supply</li> <li>• Pneumatic spring return</li> <li>• Reversible</li> <li>• Operating pressure –0.09 ... +1 MPa</li> <li>• Available in width of 10 mm, 14 mm and 20 mm</li> </ul> <p>Compressed air (–0.9 ... +10 bar) supplied at working port 4 can be switched with both internal and external pilot air supply.</p>

2x 2/2-way valve		
Circuit symbol	Code	Description
	Position function 1-32: D	<ul style="list-style-type: none"> <li>• Single solenoid</li> <li>• Normally closed</li> <li>• Pneumatic spring return</li> <li>• Operating pressure 0.3 ... 1 MPa</li> <li>• Available in width of 10 mm, 14 mm and 20 mm</li> </ul>
	Position function 1-32: DS	<ul style="list-style-type: none"> <li>• Single solenoid</li> <li>• Normally closed</li> <li>• Mechanical spring return</li> <li>• Reversible</li> <li>• Operating pressure –0.09 ... +0.8 MPa</li> <li>• Available in width of 10 mm, 14 mm and 20 mm</li> </ul>
	Position function 1-32: I	<ul style="list-style-type: none"> <li>• Single solenoid</li> <li>• 1x normally closed</li> <li>• 1x normally closed, reversible only</li> <li>• Pneumatic spring return</li> <li>• Operating pressure 0.3 ... 1 MPa</li> <li>• Vacuum at port 3/5 only</li> <li>• Available in width of 10 mm, 14 mm and 20 mm</li> </ul>



## Characteristics – Pneumatic components

### Cover plate

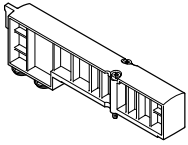

Cover plate (code L) without valve function, for reserving valve positions on a valve terminal.

Valves and cover plates are attached to the sub-base using two screws.

### Exhaust functions

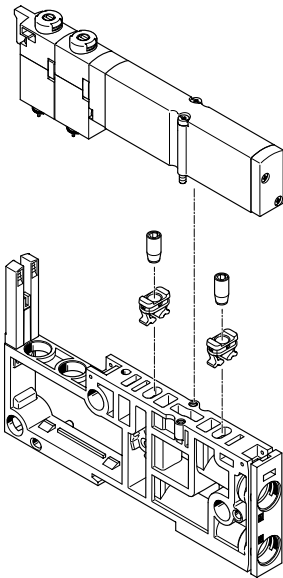

#### Fixed flow restrictor

The fixed flow restrictor can be used to permanently set the exhaust flow rate in ducts 3 and 5.

Assembly:

- Press the retainer as far as it will go into the exhaust openings on the sub-base
- Screw the fixed flow restrictor into the retainer
- Mount the valve on the sub-base

The restrictor cuts a thread into the retainer as it is screwed in. For that reason, the retainer should also be changed when a restrictor is repeatedly replaced.

The restrictor is available in 7 different nominal widths (0.3 ... 1.7 mm). The individual sizes are colour-coded for ease of identification.

Fixed flow restrictors enable, for example, the cylinder speed to be set to a predefined limit in response to known flow rate conditions.

They cannot be accessed during operation and are therefore protected against manipulation.

This is beneficial in the production of series machines since the required speed can be determined once and the installation simply duplicated for further machines, saving time and costs for repeated commissioning.

#### Note

The fixed flow restrictors are available only for valves or manifold sub-bases with a width of 10 mm.

#### Check valve

The check valves prevent the air from being pushed back (back pressure) from ducts 3 and 5 into the solenoid valve.

This prevents the back pressure from having a disruptive effect on other connected actuators.

The check valves are integrated into ducts 3 and 5 of the sub-bases.

The check valves should be installed according to the specifications using the enclosed assembly tool. Following assembly, the check valves cannot be removed.

Please see the relevant assembly instructions:

- [www.festo.com/catalogue/...](http://www.festo.com/catalogue/...)
- Support/Downloads

#### Note

- Pre-assembled sub-bases with integrated check valves are available.
- It is not possible to use a check valve and a fixed flow restrictor (in the same duct) at the same time.

## Characteristics – Pneumatic components

### Vertical stacking

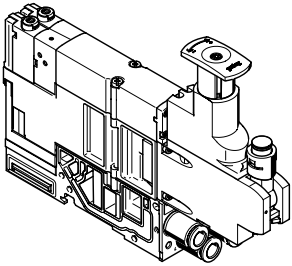

Additional functional units can be added to each valve position between the base plate and the valve.

These functions are known as vertical stacking modules and enable special functions or control of an individual valve position.

### Pressure regulator plate

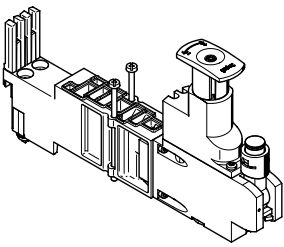

An adjustable pressure regulator can be installed between the base plate and the valve to control the force of the actuator.

This pressure regulator maintains a constant output pressure (secondary side) independent of pressure fluctuations (primary side) and air consumption.

Standard version:

- For pressure regulation up to 6 bar or up to 10 bar
- Without pressure gauge (optional, can be swivelled)
- Set using screwdriver or regulator head

### Vertical pressure shut-off plate for width of 10 mm and 14 mm

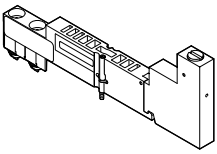

The vertical pressure shut-off plate can be used to hot swap individual valves without switching off the overall air supply.

The working pressure for the individual valve can be switched off manually via the vertical pressure shut-off plate using the actuating element.

### Vertical pressure supply plate for width of 14 mm and 20 mm

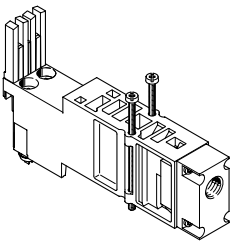

This vertical pressure supply plate enables an individual valve to be supplied with individual operating pressure independently of the operating pressure of the valve terminal.

The exhaust and pilot air supply of the valve are still provided via the central ports of the valve terminal.

## Characteristics – Pneumatic components

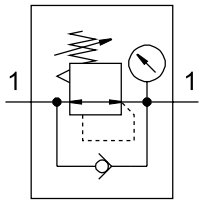
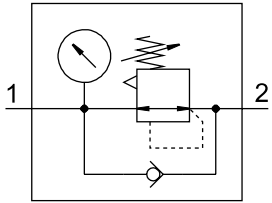
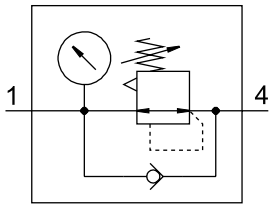
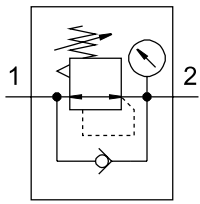
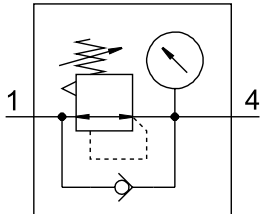
Pressure regulator		
Circuit symbol	Code	Description
	Pressure regulator 1-32: PA Pressure regulator 1-32: PF	<ul style="list-style-type: none"> <li>Regulates the pressure upstream of the valve in duct 1</li> <li>Same regulated pressure at duct 2 and duct 4</li> <li>Exhausting in the valve from duct 2 to duct 3 and from duct 4 to duct 5</li> <li>Regulator not affected by exhausting</li> <li>Regulator can always be adjusted</li> <li>Available in width of 10 mm, 14 mm and 20 mm</li> </ul>
	Pressure regulator 1-32: PC Pressure regulator 1-32: PH	<ul style="list-style-type: none"> <li>Regulates the pressure for duct 2 downstream of the valve</li> <li>Exhausting via the regulator from duct 2 to duct 3</li> <li>Exhaust flow is restricted by the regulator</li> <li>Regulator can only be adjusted in switched state</li> <li>Available in width of 10 mm, 14 mm and 20 mm</li> </ul>
	Pressure regulator 1-32: PB Pressure regulator 1-32: PG	<ul style="list-style-type: none"> <li>Regulates the pressure for duct 4 downstream of the valve</li> <li>Exhausting via the regulator from duct 4 to duct 5</li> <li>Exhaust flow is restricted by the regulator</li> <li>Regulator can only be adjusted in switched state</li> <li>Available in width of 10 mm, 14 mm and 20 mm</li> </ul>
	Pressure regulator 1-32: PN Pressure regulator 1-32: PL	<ul style="list-style-type: none"> <li>Splits the supply air in duct 1 and regulates the pressure upstream of the valve in duct 3</li> <li>Valve is operated in reverse mode</li> <li>Exhausting in the valve from duct 2 to duct 1</li> <li>Regulator not affected by exhausting</li> <li>Regulator can always be adjusted</li> <li>Available in width of 20 mm</li> </ul>
	Pressure regulator 1-32: PK Pressure regulator 1-32: PM	<ul style="list-style-type: none"> <li>Splits the supply air in duct 1 and regulates the pressure upstream of the valve in duct 5</li> <li>Valve is operated in reverse mode</li> <li>Exhausting in the valve from duct 4 to duct 1</li> <li>Regulator not affected by exhausting</li> <li>Regulator can always be adjusted</li> <li>Available in width of 20 mm</li> </ul>

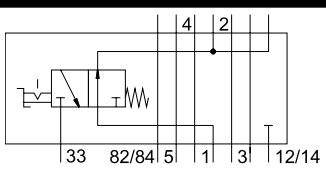
Vertical pressure shut-off plate		
Circuit symbol	Code	Description
	Pressure regulator 1-32: PS	<ul style="list-style-type: none"> <li>Makes it possible to shut down pressure in duct 1 and duct 12/14 upstream of the valve</li> <li>Exhausting in the valve from duct 2 to duct 3 and from duct 4 to duct 5</li> <li>Vertical pressure shut-off plate not affected by exhausting</li> <li>Operating pressure 3 ... 8 bar</li> <li>Available in width of 10 mm and 14 mm</li> </ul>

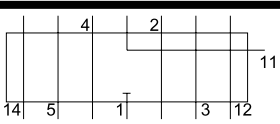
Vertical pressure supply plate		
Circuit symbol	Code	Description
	Pressure regulator 1-32: PV	<ul style="list-style-type: none"> <li>Enables separate supply of the pressure in duct 1 and upstream of the valve</li> <li>Operating pressure -0.9 ... +10 bar</li> <li>Available in width of 14 mm and 20 mm</li> </ul>

## Characteristics – Pneumatic components

### Compressed air supply and exhausting

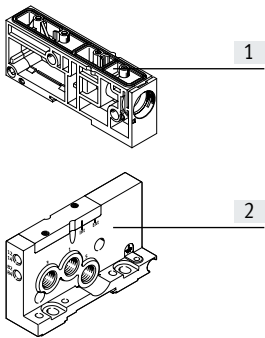

- [1] Supply module
- [2] Right-hand end plate

The valve terminal MPA-L can be supplied with compressed air at one or more points via supply modules and/or the right-hand end plate. The generously sized pneumatic system enables good performance from all components, even with large-scale expansions.

Exhausting (ducts 3 and 5) either takes place via silencers or ports for ducted exhaust air via the supply modules or the right-hand end plate.

There are two types of supply module with exhausting:

- Exhaust air 3/5 via flat plate silencer
- Exhaust air 3/5 ducted

Exhausting (ducts 3 and 5) can alternatively or additionally take place via the right-hand end plate.

Ducts 3 and 5 are separate in the terminal and are only joined together in the supply module. The pilot exhaust air (duct 82/84) is completely separate from ducts 3 and 5.

### Pilot air supply

The valve terminal MPA-L is supplied with pilot air exclusively via the right-hand end plate. The pilot air supply

can be selected at the pilot air selector on the end plate:

- Internal (from duct 1) or
- External (from duct 12/14)

#### Switching position for internal, marked "Int"

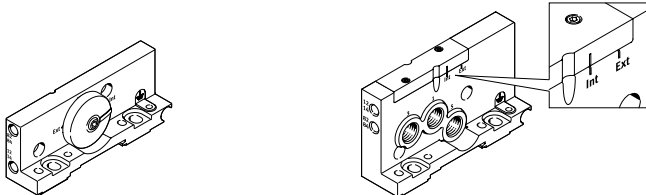

Internal pilot air supply can be selected if the supply pressure for the terminal is between 0.3 and 0.8 MPa. In this case, the pilot air supply is branched by an internal connection

from duct 1 in the right-hand end plate.

Port 12/14 on the right-hand end plate can be sealed using a blanking plug.

#### Switching position for external, marked "Ext"

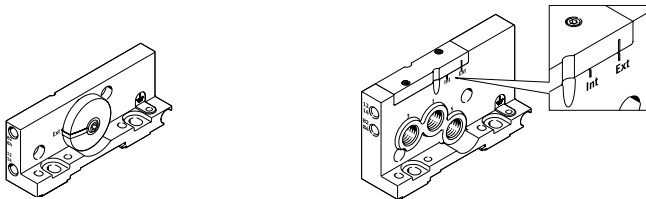

If the supply pressure (at the right-hand end plate) is less than 0.3 MPa or greater than 0.8 MPa, then the valve terminal MPA-L must be operated with an external pilot air supply. The pilot air is then supplied via port 12/14 on the right-hand end plate. When using

several pressure zones, the supply pressure in the pressure zone with the right-hand end plate is decisive.

#### - Note

If a gradual pressure build-up in the system using a soft-start valve is chosen, an external pilot air supply should be connected so that the pilot pressure applied during switch-on is already very high.

## Characteristics – Pneumatic components

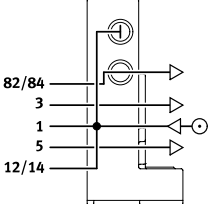
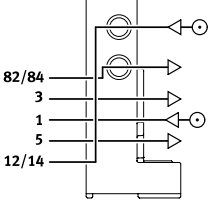
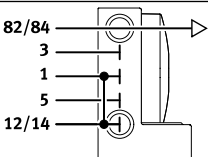
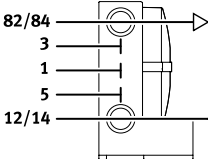
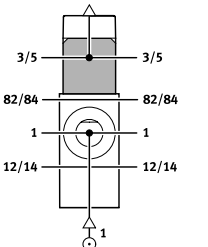
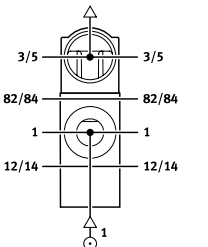
Compressed air supply and pilot air supply		
Graphical illustration	Code	Notes
<b>Right-hand end plate, with supply ports</b>		
	Right-hand end plate: D Pilot air: –	Internal pilot air supply <ul style="list-style-type: none"> <li>Pilot air is branched internally from port 1 in the right-hand end plate</li> <li>Exhaust air 3/5 via right-hand end plate or supply module</li> <li>Pilot exhaust air 82/84 via right-hand end plate</li> <li>For operating pressure in the range 0.3 ... 0.8 MPa</li> </ul>
	Right-hand end plate: D Pilot air: E	External pilot air supply <ul style="list-style-type: none"> <li>Pilot air supply (0.3 ... 0.8 MPa) is connected at port 12/14 on the right-hand end plate</li> <li>Exhaust air 3/5 via right-hand end plate or supply module</li> <li>Pilot exhaust air 82/84 via right-hand end plate</li> <li>For operating pressure in the range –0.09 ... +1 MPa (suitable for vacuum)</li> </ul>
<b>Right-hand end plate, without supply ports</b>		
	Right-hand end plate: – Pilot air: –	Internal pilot air supply <ul style="list-style-type: none"> <li>Pilot air is branched internally from port 1 in the right-hand end plate</li> <li>Exhaust air 3/5 via supply module</li> <li>Pilot exhaust air 82/84 via right-hand end plate</li> <li>For operating pressure in the range 0.3 ... 0.8 MPa</li> </ul>
	Right-hand end plate: – Pilot air: E	External pilot air supply <ul style="list-style-type: none"> <li>Pilot air supply (0.3 ... 0.8 MPa) is connected at port 12/14 on the right-hand end plate</li> <li>Exhaust air 3/5 via supply module</li> <li>Pilot exhaust air 82/84 via right-hand end plate</li> <li>For operating pressure in the range –0.09 ... +1 MPa (suitable for vacuum)</li> </ul>
<b>Supply module, flat plate silencer</b>		
	Type of module block 1-40: U Exhaust port: –	<ul style="list-style-type: none"> <li>Exhaust air 3/5 via flat plate silencer</li> <li>Pilot exhaust air 82/84 via right-hand end plate</li> <li>For operating pressure in the range –0.09 ... +1 MPa (suitable for vacuum)</li> </ul>
<b>Supply module, ducted exhaust air</b>		
	Type of module block 1-40: U Exhaust port: UD, UE, UF, UM, UN, UP or UG	<ul style="list-style-type: none"> <li>Exhaust air 3/5 via supply module</li> <li>Pilot exhaust air 82/84 via right-hand end plate</li> <li>For operating pressure in the range –0.09 ... +1 MPa (suitable for vacuum)</li> </ul>

Characteristics – Pneumatic components

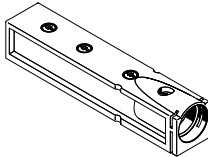
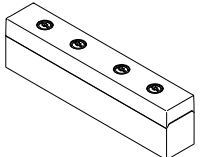
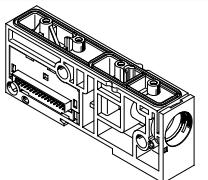
Supply module				
Graphical illustration	Code	Type	Designation	Notes
	Exhaust port: UD, UE, UF, UM, UN, UP or UG	VMPAL-EG	Exhaust plate for ducted exhaust air	Additional supply modules can be used for larger terminals or to create pressure zones. Supply modules can be configured at any point upstream or downstream of the sub-bases. Supply modules contain the following ports: • Compressed air supply (duct 1) • Exhaust air (duct 3/5)
	Exhaust port: –	VMPAL-EU	Flat plate silencer	
	Type of module block 1-40: U	VMPAL-SP-0	Supply module with electrical manifold module	

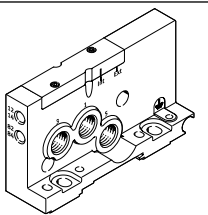
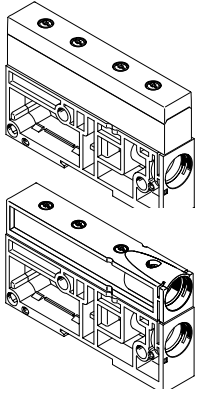
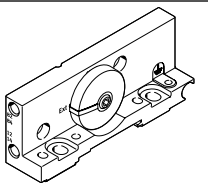
Ports for supply and exhaust					
	Code	Port		Push-in fitting/cartridge	
<b>Right-hand end plate with supply ports 1, 3, 5</b>					
	Right-hand end plate: D	1	Work air/vacuum supply	G1/4 thread	Straight or angled push-in fitting, for tubing O.D. 8 mm, 10 mm, 12 mm, 5/16", 3/8"
		3	Exhaust air	G1/4 thread	
		5	Exhaust air	G1/4 thread	
		12/14	Pilot air supply	M7 thread	Straight or angled push-in fitting, for tubing O.D. 4 mm, 6 mm Straight push-in fitting, for tubing O.D. 3/16", 1/4"
		82/84	Pilot exhaust air	M7 thread	
<b>Supply module</b>					
	Type of module block 1-40: U	1	Work air/vacuum supply	Cartridge	Straight cartridge, for tubing O.D. 8 mm, 10 mm, 12 mm, 5/16", 3/8", 1/2", adapter for thread G1/4
		3/5	Exhaust air	Flat plate silencer	
				Cartridge	Straight cartridge, for tubing O.D. 8 mm, 10 mm, 12 mm, 5/16", 3/8", 1/2", adapter for thread G1/4
		12/14	Pilot air supply	–	–
		82/84	Pilot exhaust air	–	–
<b>Right-hand end plate without supply ports</b>					
	Right-hand end plate: –	1	Work air/vacuum supply	–	–
		3	Exhaust air	–	–
		5	Exhaust air	–	–
		12/14	Pilot air supply	M7 thread	Straight or angled push-in fitting, for tubing O.D. 4 mm, 6 mm Straight push-in fitting, for tubing O.D. 3/16", 1/4"
		82/84	Pilot exhaust air	M7 thread	

## Characteristics – Pneumatic components

### Creating pressure zones and separating exhaust air

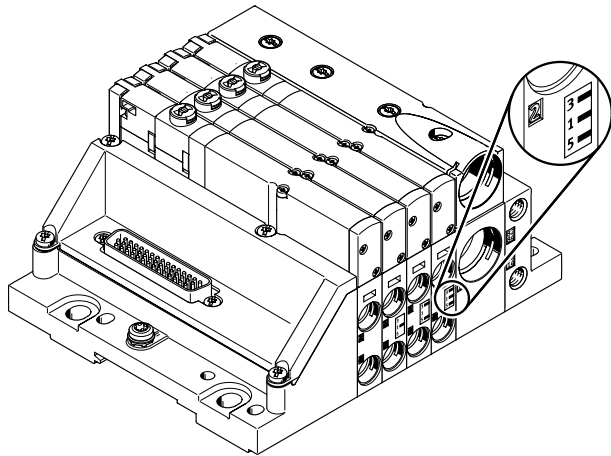

MPA-L offers a number of options for creating pressure zones if different working pressures are required. A total of up to 20 pressure zones can be created.

Pressure zones are created by isolating the internal supply ducts in a special sub-base. Each pressure zone must have its own compressed air supply. Compressed air can be supplied and exhausted via a supply module and/or the right-hand end plate.

The position of the supply modules and the sub-bases with pressure zone separation can be freely chosen with the valve terminal MPA-L.

The sub-bases with pressure zone separation are integrated into the terminal at the factory as specified in your order.

They can be distinguished by their coding, even when the valve terminal is assembled. Duct separation always takes place to the right of the sub-base.

### Creating pressure zones

Sub-bases with pressure zone separation

Illustrated examples

Illustrated examples	Coding	Code	Notes
		Duct separation to the right of sub-base 1 - 40: -	• No duct separation
		Duct separation to the right of sub-base 1 - 40: T	• Duct 1 separated • VMPAL...-T1
		Duct separation to the right of sub-base 1 - 40: TR	• Duct 3/5 separated • VMPAL...-T35
		Duct separation to the right of sub-base 1 - 40: TS	• Ducts 1 and 3/5 separated • VMPAL...-T135

## Characteristics – Pneumatic components

### Examples: compressed air supply and pilot air supply

#### Internal pilot air supply, right-hand end plate without supply ports

The adjacent diagram shows an example of the configuration and connection of the air supply with internal pilot air supply.

The exhaust air (duct 3/5) is discharged via supply modules.

The pilot exhaust air (duct 82/84) is discharged via the right-hand end plate.

Special sub-bases are used to create pressure zones.

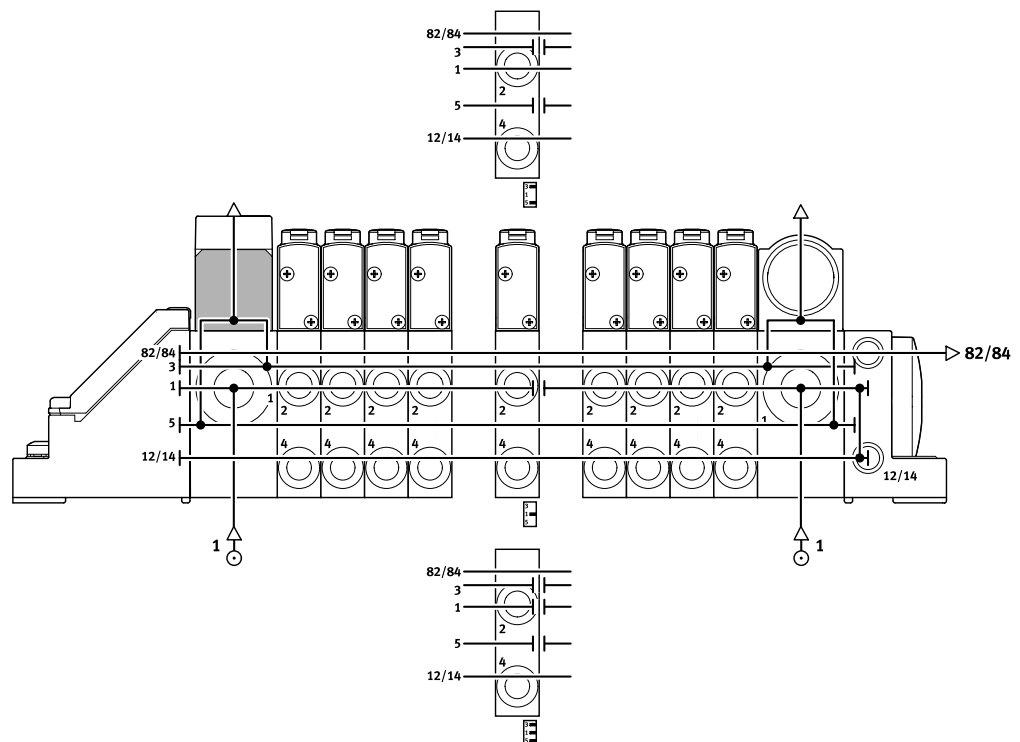

#### External pilot air supply, right-hand end plate without supply ports

The adjacent diagram shows an example of the configuration and connection of the compressed air supply with external pilot air supply. Port 12/14 on the right-hand end plate is equipped with a fitting for this.

The exhaust air (duct 3/5) is discharged via supply modules.

The pilot exhaust air (duct 82/84) is discharged via the right-hand end plate.

Special sub-bases are used to create pressure zones.

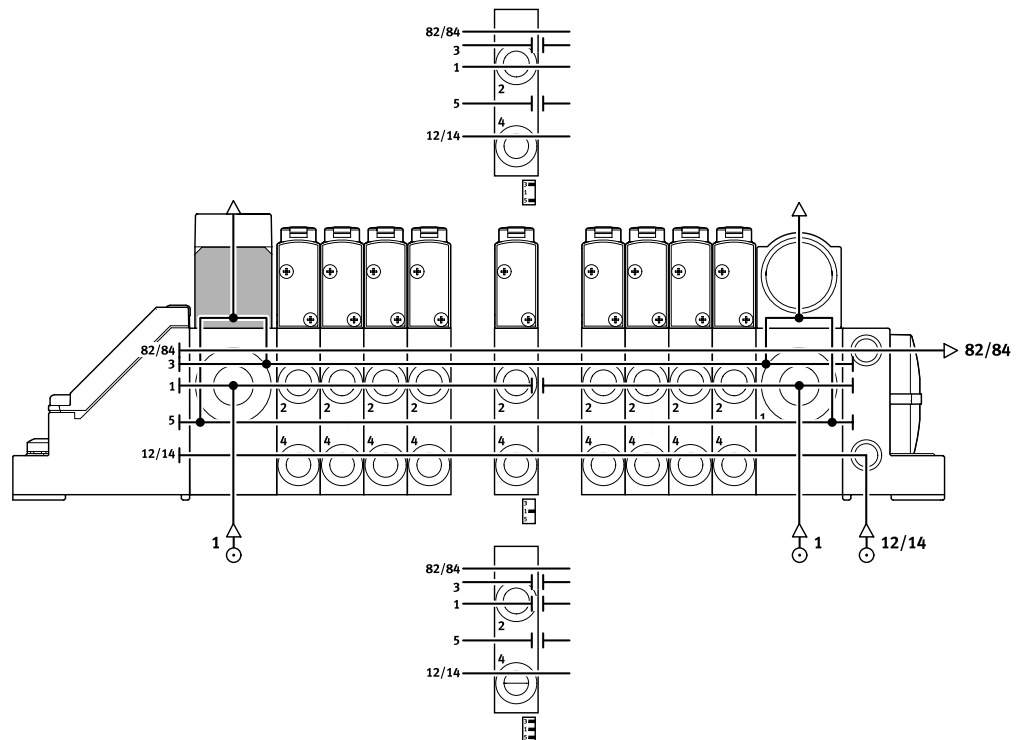



## Characteristics – Pneumatic components

## Sub-base

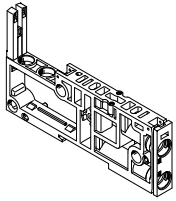

MPA-L is based on a modular system consisting of sub-bases and valves. The sub-bases are joined together using tie rods and thus form the support system for the valves. They contain the ducts for supplying compressed air to and exhausting from the valve terminal as well as the working ports for the pneumatic drives for each valve. The tie rod used to join the sub-bases together consists of a threaded rod, threaded sleeve and screw.

In principle, sub-bases have a modular structure. If this modularity is not required within a terminal, then four individual sub-bases can be combined with a 4-way electrical manifold module to save costs. The threaded rod/sleeve combination is selected as appropriate to the number and width of the individual sub-bases or sub-base combination. To add further blocks, simply loosen the tie rod and adapt with extenders.

There are no restrictions on extensions; a tie rod could be constructed almost entirely from extenders.

Sub-base variants			
Graphical illustration	Code	Type	Notes
	-	VMPAL-AP-10 VMPAL-AP-14 VMPAL-AP-20	<ul style="list-style-type: none"> <li>Without cartridge</li> <li>Without electrical manifold module</li> </ul>
		VMPAL-AP-...-QS...-1... VMPAL-AP-...-QS...-2...	<ul style="list-style-type: none"> <li>With cartridge (push-in connector for compressed air tubing with standard O.D.)</li> <li>With electrical manifold module</li> <li>With/without duct separation</li> </ul>
		VMPAL-AP-...-T1...	<ul style="list-style-type: none"> <li>Duct separation in duct 1</li> <li>With/without cartridge (push-in connector for compressed air tubing with standard O.D.)</li> <li>With/without electrical manifold module</li> <li>With/without check valve in duct 3 and 5</li> </ul>
		VMPAL-AP-...-T35...	<ul style="list-style-type: none"> <li>Duct separation in ducts 3 and 5</li> <li>Without electrical manifold module</li> <li>With/without check valve in duct 3 and 5</li> </ul>
		VMPAL-AP-...-T135...	<ul style="list-style-type: none"> <li>Duct separation in ducts 1, 3 and 5</li> <li>Without electrical manifold module</li> <li>With/without check valve in duct 3 and 5</li> </ul>
		VMPAL-AP-...-RV	<ul style="list-style-type: none"> <li>With check valve in duct 3 and 5</li> <li>Without electrical manifold module</li> <li>With/without duct separation</li> </ul>
			Combination manifold block: Z

Characteristics – Pneumatic components

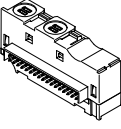
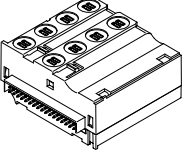
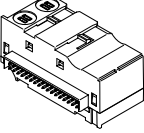
Electrical manifold module Graphical illustration	Code	Type	No. of solenoid coils (valve positions)	Notes
	Type of module block 1-40: A	VMPAL-EVAP-10-...-2	2 (1), double solenoid	Each solenoid coil must be assigned to a specific pin of the multi-pin plug for the valves to be actuated. Regardless of whether cover plates or valves are used, valve positions occupy: <ul style="list-style-type: none"> <li>• One coil/address (single solenoid valves)</li> <li>• Two coils/addresses (double solenoid valves)</li> </ul>
	Type of module block 1-40: E	VMPAL-EVAP-14-...-2		
	Type of module block 1-40: B	VMPAL-EVAP-20-...-2		
	Type of module block 1-40: C	VMPAL-EVAP-10-...-1	1 (1), single solenoid	The electrical manifold modules are colour-coded: <ul style="list-style-type: none"> <li>• Single solenoid – grey</li> <li>• Double solenoid – black</li> </ul>
	Type of module block 1-40: F	VMPAL-EVAP-14-...-1		
	Type of module block 1-40: D	VMPAL-EVAP-20-...-1		
	Type of module block 1-40: A	VMPAL-EVAP-10-2-4	8 (4), double solenoid	Each solenoid coil must be assigned to a specific pin of the multi-pin plug for the valves to be actuated. Regardless of whether cover plates or valves are used, valve positions occupy: <ul style="list-style-type: none"> <li>• One coil/address (single solenoid valves)</li> <li>• Two coils/addresses (double solenoid valves)</li> </ul>
	Type of module block 1-40: E	VMPAL-EVAP-14-2-4		
	Type of module block 1-40: C	VMPAL-EVAP-10-1-4	4 (4), single solenoid	<ul style="list-style-type: none"> <li>• One coil/address (single solenoid valves)</li> <li>• Two coils/addresses (double solenoid valves)</li> </ul>
	Type of module block 1-40: F	VMPAL-EVAP-14-1-4		
	Type of module block 1-40: U	VMPAL-EVAP-20-SP	–	Electrical manifold module for supply module

## Characteristics – Mounting

### Valve terminal mounting

Sturdy terminal mounting via:

- Four through-holes for wall mounting
- Additional mounting brackets
- H-rail mounting

#### Note

If the terminal is subject to strong vibrations or shock loads, use additional mounting brackets of the type VMPAL-BD for wall mounting. These should be attached to the valve terminal every 13 cm (one

mounting bracket every 10 valve positions).

### Wall mounting – Multi-pin plug connection

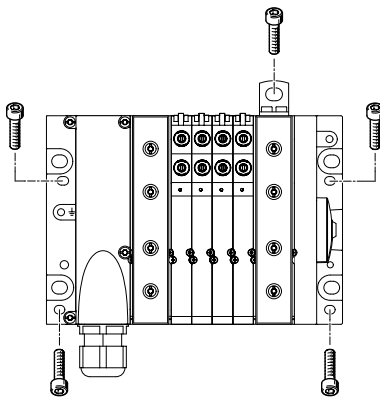

The MPA-L valve terminal is screwed onto the mounting surface using four M4 or M6 screws. The mounting holes are on the multi-pin plug connection and on the right-hand end plate. Optional mounting brackets are also available.

### Wall mounting – Fieldbus interface (CPX terminal)

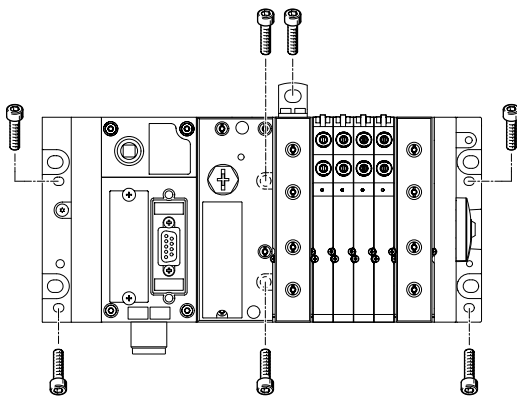

The MPA-L valve terminal is screwed onto the mounting surface using four M4 and two M6 screws or using six M6 screws. The mounting holes are on the left-hand and right-hand end plate and on the pneumatic interface. Optional mounting brackets are also available.

### H-rail mounting

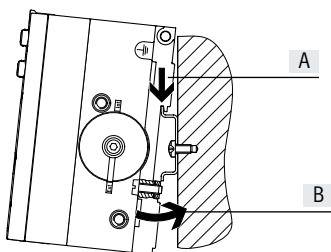

The MPA-L valve terminal is attached to the H-rail (see arrow A).

The MPA-L valve terminal is then swivelled onto the H-rail and secured in place with the clamping element (see arrow B).

The following MPA-L mounting kit is required for H-rail mounting of the valve terminal:

- With multi-pin plug connection:
- CPX-CPA-BG-NRH
- With fieldbus interface (CPX terminal):
- VMPAF-FB-BG-NRH

This enables the valve terminal to be mounted on an H-rail to EN 60715.

#### Note

The mounting kits (see above) only lock the valve terminal in horizontal mounting position.

## Characteristics – Mounting

### Tie rod Design

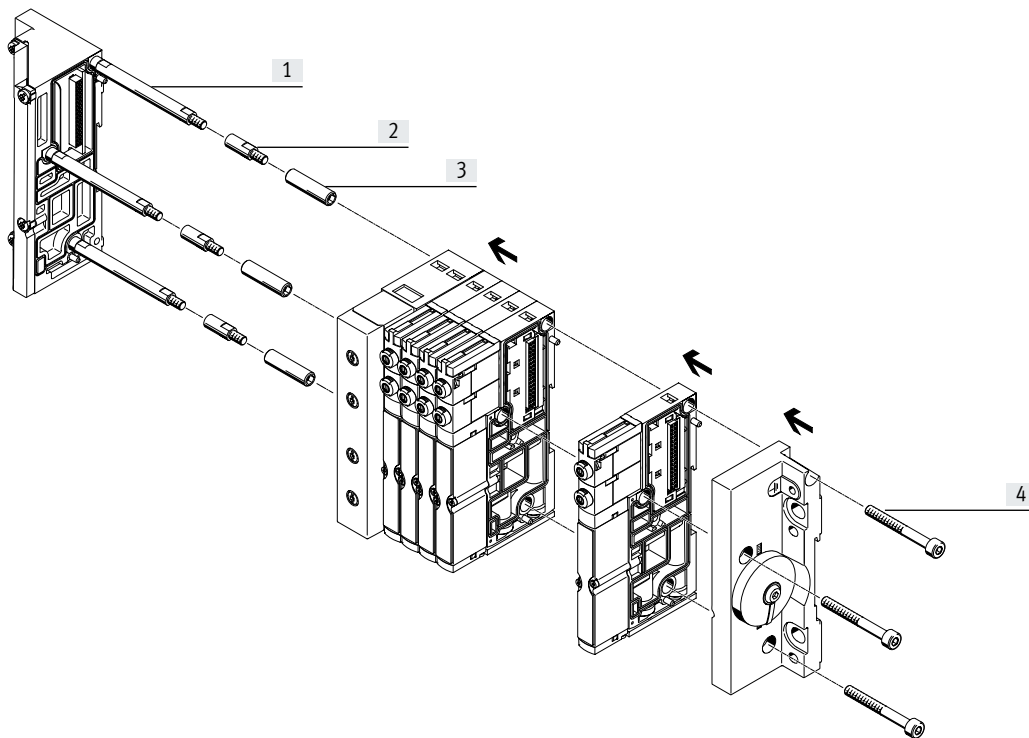

- [1] Threaded rod
- [2] Tie rod extender
- [3] Sleeve
- [4] Screw

### Mode of operation

The tie rod for MPA-L consists of four parts:

- Threaded rod
- Tie rod extender
- Sleeve
- Screw

This enables valve terminals of any length to be created.

It takes just 4 steps to assemble the tie rod and the valve terminal:

- Screw the threaded rods to the left-hand end plate
- Screw the sleeves to the threaded rods
- Push the sub-bases and supply modules onto the rod/sleeve combination
- Push on the right-hand end plate and secure with screws that engage into the sleeves

The tie rod enables the valve terminal to be extended at a later date. This is

done by loosening the tie rod screws and disassembling the relevant components. The additional sub-base or supply module is inserted at the required location. The previously disassembled components are then re-assembled.

To compensate for the change in length, the tie rod must be extended by the increase in length. This is done by screwing in extenders between the threaded rod and sleeve. There are suitable extenders for each sub-base, combination of four sub-bases and supply module.

## Characteristics – Mounting

### Tie rod – Components and design

#### Tie rod (threaded rod)



The threaded rod is used to construct a cost-optimised fixed-grid tie rod. The threaded rod is required with valve terminal lengths exceeding 42.45 mm, for example at least four sub-bases (10.7 mm each), since only the combination of a threaded rod and sleeve offers the optimum compensation of tolerances (by compressing the seals between the sub-bases).

#### Tie rod extender

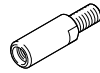

The valve terminal can be extended almost infinitely at any time using tie rod extenders. The tie rod extenders are inserted between the threaded rod and sleeve and are available in appropriate lengths for sub-bases and supply modules.

#### Sleeve

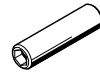

The primary purpose of the sleeve is to compensate for tolerances that occur, for example, when the seals are compressed between the sub-bases during assembly. The sleeves come in different lengths, tailored to the use of a tie rod in a fixed grid as well as generally for the individual modular tie rods.

#### Screw



The entire valve terminal is clamped via the tie rod using the screw. Tolerances that occur, for example when the seals are compressed between the sub-bases during assembly, are compensated for by the interaction of the screw and sleeve.

### Individual modular tie rod

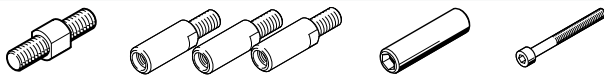

Tie rods can be constructed entirely using tie rod extenders. The threaded rod and sleeve are required to compensate for tolerances that occur, for example, when the

seals are compressed between the sub-bases during assembly.

### Fixed-grid tie rod with extension



The tie rod extenders are inserted between the threaded rod and the sleeve.

They are available in suitable lengths for sub-bases and supply modules.

### Fixed-grid tie rod



The fixed-grid tie rod minimises assembly work when assembling previously defined valve terminals. These valve terminals can be extended at any time.

The threaded rod (and, if applicable, the sleeve too) must be replaced if the valve terminal length is reduced.

### Short valve terminal

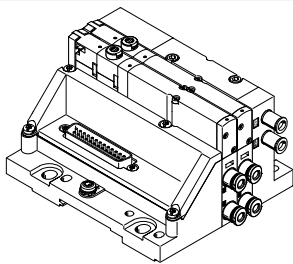

Valve terminals with a small number of valve positions are created by means of the following combinations:

#### Width 10 mm

- Valve terminals with two valve positions and without a supply module are connected solely using screws
- Valve terminals with three valve positions and without a supply module (or with one valve position and one supply module) are connected using a 10 mm tie rod extender and screw

#### Width 14 mm

- Valve terminals with two valve positions and without a supply module are connected using a 10 mm tie rod extender and screw

## Characteristics – Mounting

Ordering data – Fixed-grid tie rod				
Reference length	Part no.	Type	Part no.	Type
<b>L = 10.65 x V + 14.85 x W + 21.15 x Z + 21.15 x S</b>	<b>Tie rod</b>		<b>Sleeve</b>	
42.30 ... 62.64	561116	VMPAL-ZAS-5	561135	VMPAL-ZAH-36
62.65 ... 72.29	561116	VMPAL-ZAS-5	561136	VMPAL-ZAH-46
72.30 ... 81.94	561116	VMPAL-ZAS-5	561137	VMPAL-ZAH-56
81.95 ... 91.59	561116	VMPAL-ZAS-5	561138	VMPAL-ZAH-66
91.60 ... 101.24	561117	VMPAL-ZAS-45	561135	VMPAL-ZAH-36
101.25 ... 110.89	561117	VMPAL-ZAS-45	561136	VMPAL-ZAH-46
110.90 ... 120.54	561117	VMPAL-ZAS-45	561137	VMPAL-ZAH-56
120.55 ... 130.19	561117	VMPAL-ZAS-45	561138	VMPAL-ZAH-66
130.20 ... 139.84	561118	VMPAL-ZAS-85	561135	VMPAL-ZAH-36
139.85 ... 149.49	561118	VMPAL-ZAS-85	561136	VMPAL-ZAH-46
149.50 ... 159.49	561118	VMPAL-ZAS-85	561137	VMPAL-ZAH-56
159.50 ... 169.14	561118	VMPAL-ZAS-85	561138	VMPAL-ZAH-66
169.15 ... 178.79	561119	VMPAL-ZAS-125	561135	VMPAL-ZAH-36
178.80 ... 188.44	561119	VMPAL-ZAS-125	561136	VMPAL-ZAH-46
188.45 ... 198.09	561119	VMPAL-ZAS-125	561137	VMPAL-ZAH-56
198.10 ... 207.74	561119	VMPAL-ZAS-125	561138	VMPAL-ZAH-66
207.75 ... 217.39	561120	VMPAL-ZAS-165	561135	VMPAL-ZAH-36
217.40 ... 227.04	561120	VMPAL-ZAS-165	561136	VMPAL-ZAH-46
227.05 ... 236.69	561120	VMPAL-ZAS-165	561137	VMPAL-ZAH-56
236.70 ... 246.34	561120	VMPAL-ZAS-165	561138	VMPAL-ZAH-66
246.35 ... 255.99	561121	VMPAL-ZAS-205	561135	VMPAL-ZAH-36
256.00 ... 265.99	561121	VMPAL-ZAS-205	561136	VMPAL-ZAH-46
266.00 ... 275.64	561121	VMPAL-ZAS-205	561137	VMPAL-ZAH-56
275.65 ... 285.29	561121	VMPAL-ZAS-205	561138	VMPAL-ZAH-66
285.30 ... 294.94	561122	VMPAL-ZAS-245	561135	VMPAL-ZAH-36
294.95 ... 304.59	561122	VMPAL-ZAS-245	561136	VMPAL-ZAH-46
304.60 ... 314.24	561122	VMPAL-ZAS-245	561137	VMPAL-ZAH-56
314.25 ... 323.89	561122	VMPAL-ZAS-245	561138	VMPAL-ZAH-66
323.90 ... 333.54	561123	VMPAL-ZAS-285	561135	VMPAL-ZAH-36
333.55 ... 343.19	561123	VMPAL-ZAS-285	561136	VMPAL-ZAH-46
343.20 ... 352.84	561123	VMPAL-ZAS-285	561137	VMPAL-ZAH-56
352.85 ... 362.49	561123	VMPAL-ZAS-285	561138	VMPAL-ZAH-66
362.50 ... 372.49	561124	VMPAL-ZAS-325	561135	VMPAL-ZAH-36
372.50 ... 382.49	561124	VMPAL-ZAS-325	561136	VMPAL-ZAH-46
382.50 ... 392.49	561124	VMPAL-ZAS-325	561137	VMPAL-ZAH-56
392.50 ... 402.49	561124	VMPAL-ZAS-325	561138	VMPAL-ZAH-66
402.50 ... 412.49	561125	VMPAL-ZAS-365	561135	VMPAL-ZAH-36
412.50 ... 422.49	561125	VMPAL-ZAS-365	561136	VMPAL-ZAH-46
422.50 ... 432.49	561125	VMPAL-ZAS-365	561137	VMPAL-ZAH-56
432.50 ... 442.49	561125	VMPAL-ZAS-365	561138	VMPAL-ZAH-66
442.50 ... 452.49	561126	VMPAL-ZAS-405	561135	VMPAL-ZAH-36
452.50 ... 462.49	561126	VMPAL-ZAS-405	561136	VMPAL-ZAH-46
462.50 ... 472.49	561126	VMPAL-ZAS-405	561137	VMPAL-ZAH-56
472.50 ... 482.49	561126	VMPAL-ZAS-405	561138	VMPAL-ZAH-66
482.50 ... 492.49	561127	VMPAL-ZAS-445	561135	VMPAL-ZAH-36
492.50 ... 502.49	561127	VMPAL-ZAS-445	561136	VMPAL-ZAH-46
502.50 ... 512.49	561127	VMPAL-ZAS-445	561137	VMPAL-ZAH-56
512.50 ... 522.49	561127	VMPAL-ZAS-445	561138	VMPAL-ZAH-66

- V Number of valve positions in width 10 mm
- W Number of valve positions in width 14 mm
- Z Number of valve positions in width 20 mm
- S Number of supply modules

## Characteristics – Mounting

Ordering data – Fixed-grid tie rod				
Reference length	Part no.	Type	Part no.	Type
<b>L = 10.65 x V + 14.85 x W + 21.15 x Z + 21.15 x S</b>	<b>Tie rod</b>		<b>Sleeve</b>	
522.50 ... 532.49	561128	VMPAL-ZAS-485	561135	VMPAL-ZAH-36
532.50 ... 542.49	561128	VMPAL-ZAS-485	561136	VMPAL-ZAH-46
542.50 ... 552.49	561128	VMPAL-ZAS-485	561137	VMPAL-ZAH-56
552.50 ... 562.49	561128	VMPAL-ZAS-485	561138	VMPAL-ZAH-66
562.50 ... 572.49	561129	VMPAL-ZAS-525	561135	VMPAL-ZAH-36
572.50 ... 582.49	561129	VMPAL-ZAS-525	561136	VMPAL-ZAH-46
582.50 ... 592.49	561129	VMPAL-ZAS-525	561137	VMPAL-ZAH-56
592.50 ... 602.49	561129	VMPAL-ZAS-525	561138	VMPAL-ZAH-66
602.50 ... 612.49	561130	VMPAL-ZAS-565	561135	VMPAL-ZAH-36
612.50 ... 622.49	561130	VMPAL-ZAS-565	561136	VMPAL-ZAH-46
622.50 ... 632.49	561130	VMPAL-ZAS-565	561137	VMPAL-ZAH-56
632.50 ... 642.49	561130	VMPAL-ZAS-565	561138	VMPAL-ZAH-66
642.50 ... 652.49	561131	VMPAL-ZAS-605	561135	VMPAL-ZAH-36
652.50 ... 662.49	561131	VMPAL-ZAS-605	561136	VMPAL-ZAH-46
662.50 ... 672.49	561131	VMPAL-ZAS-605	561137	VMPAL-ZAH-56
672.50 ... 682.49	561131	VMPAL-ZAS-605	561138	VMPAL-ZAH-66
682.50 ... 692.49	561132	VMPAL-ZAS-645	561135	VMPAL-ZAH-36
692.50 ... 702.49	561132	VMPAL-ZAS-645	561136	VMPAL-ZAH-46
702.50 ... 712.49	561132	VMPAL-ZAS-645	561137	VMPAL-ZAH-56
712.50 ... 722.49	561132	VMPAL-ZAS-645	561138	VMPAL-ZAH-66
722.50 ... 732.49	561133	VMPAL-ZAS-685	561135	VMPAL-ZAH-36
732.50 ... 742.49	561133	VMPAL-ZAS-685	561136	VMPAL-ZAH-46
742.50 ... 752.49	561133	VMPAL-ZAS-685	561137	VMPAL-ZAH-56
752.50 ... 762.49	561133	VMPAL-ZAS-685	561138	VMPAL-ZAH-66
762.50 ... 772.49	561134	VMPAL-ZAS-725	561135	VMPAL-ZAH-36
772.50 ... 782.49	561134	VMPAL-ZAS-725	561136	VMPAL-ZAH-46
782.50 ... 792.49	561134	VMPAL-ZAS-725	561137	VMPAL-ZAH-56
792.50 ... 802.49	561134	VMPAL-ZAS-725	561138	VMPAL-ZAH-66
802.50 ... 812.49	561175	VMPAL-ZAS-765	561135	VMPAL-ZAH-36
812.50 ... 822.49	561175	VMPAL-ZAS-765	561136	VMPAL-ZAH-46
822.50 ... 832.49	561175	VMPAL-ZAS-765	561137	VMPAL-ZAH-56
832.50 ... 842.49	561175	VMPAL-ZAS-765	561138	VMPAL-ZAH-66
842.50 ... 852.49	561176	VMPAL-ZAS-805	561135	VMPAL-ZAH-36
852.50 ... 862.49	561176	VMPAL-ZAS-805	561136	VMPAL-ZAH-46

V Number of valve positions in width 10 mm

W Number of valve positions in width 14 mm

Z Number of valve positions in width 20 mm

S Number of supply modules

## Characteristics – Display and operation

### Display and operation

#### Signal status indication

Each solenoid coil is allocated an LED that indicates its signal status.

- Indicator 12 shows the signal status of the coil for duct 2
- Indicator 14 shows the signal status of the coil for duct 4

#### Manual override

The manual override (MO) enables the valve to be switched when not electrically activated or energised.

The valve is switched by pushing the manual override.

Alternatives:

- A cover cap (code: N, code: Y or as accessory) enables the manual override to be actuated by pressing it using an appropriate tool.
- A cover cap (code: V) can be fitted over the manual override to prevent it from being accidentally actuated.

### Pneumatic connection and control elements

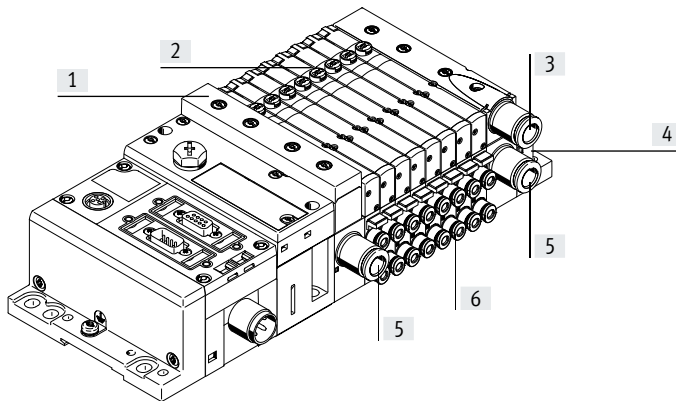

- [1] Flat plate silencer, duct 3/5
- [2] Manual override (for each pilot solenoid coil, non-detenting or non-detenting/detenting)
- [3] Ducted exhaust air, duct 3/5
- [4] Ports 12/14 for external pilot air supply and 82/84 for pilot exhaust air in the right-hand end plate (depending on version also ducts 1, 3 and 5)
- [5] Supply port, duct 1
- [6] Working ports, ducts 2 and 4, for each valve position

#### Note

A valve actuated manually (by means of the manual override) cannot be reset electrically.

Conversely, an electrically actuated valve cannot be reset using the manual override.

### Manual override (MO)

#### MO with automatic reset (non-detenting)

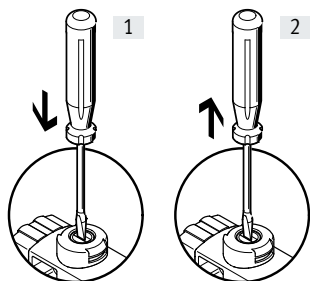

- [1] Press in the stem of the MO with a pointed object or screwdriver. Pilot valve switches and actuates the main valve.
- [2] Remove the pointed object or screwdriver. The spring force pushes the stem of the MO back. The pilot valve returns to its normal position as does the single solenoid main valve (not the case with double solenoid valve code J).

#### MO with detent (locking)

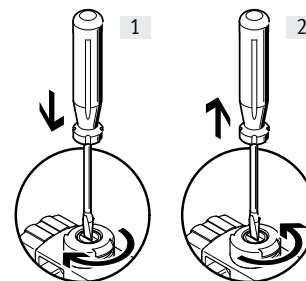

- [1] Press in the stem of the MO with a pointed object or screwdriver until the valve switches and then turn the stem clockwise by 90° until the stop is reached. The valve remains in switching position.
- [2] Turn the plunger anti-clockwise by 90° until the stop is reached and then remove the pointed object or screwdriver. The spring force pushes the stem of the MO back. The valve returns to its normal position (not the case with double solenoid valve code J).



## Characteristics – Electrical components

### Manual override (MO)

MO with cover cap, non-detenting

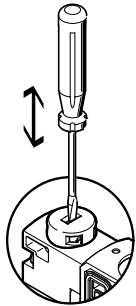

The MO is actuated by pushing it with a pointed object or screwdriver and reset by spring force (detenting position prevented due to cover cap).

MO with cover cap, detenting without accessories, mounting



Clip the covering onto the pilot valve. The MO is then actuated by moving the slide on the cover cap.

MO with cover cap, detenting without accessories, actuation

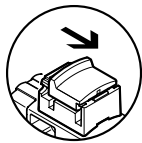

Moving the slide on the cover cap in the direction of the arrow has the following effect:

- The slide locks into the end position.
- Pilot valve switches and actuates the main valve.

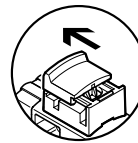

Moving the slide on the cover cap in the direction of the arrow has the following effect:

- The slide locks into the end position.
- The spring force pushes the stem of the MO back.
- The pilot valve returns to its normal position as does the single solenoid main valve (not the case with double solenoid valve code J).

### Inscription system

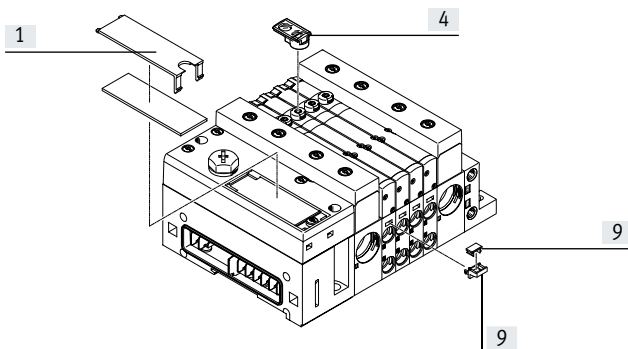

A holder VMPAL-ST-AP-10 (part no. 561109) with inscription labels (part no. 18576, IBS-6x10) can be mounted on each sub-base for labeling the valves.

The inscription label holder ASLR-D-L1 can be pushed onto the manual override.

Large inscription labels can be attached to the pneumatic interface as an alternative or in addition to the smaller labels.

### Electrical power as a result of current reduction

Each solenoid coil is protected with a spark arresting protective circuit as well as against polarity reversal.

All valve types are additionally equipped with integrated current reduction.

MPA-L valves are supplied with operating voltage in the range 21.6 ... 26.4 V (24 V +/- 10%).

## Characteristics – Electrical components

### Electrical connection – Left-hand end plate

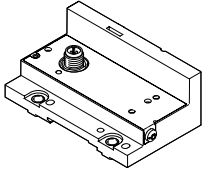

The electrical connection from the valves to a higher-order controller is in the left-hand end plate of the MPA-L.

Switching between the various connection options is easy: simply swap the left-hand end plate; the pneumatic linkage remains as is.

The valves are switched by positive or negative logic (PNP or NPN). Mixed operation is not permitted.

### Guidelines on addressing for valves/solenoid coils

- The numbering of the addresses goes from left to right in ascending consecutive order. The following applies at the individual valve positions: address x for coil 14 and address x+1 for coil 12.
- Each sub-base/electrical manifold module occupies a defined number of addresses/pins:
  - For single solenoid valve: 1
  - For double solenoid valve: 2
  - For combination of four sub-bases for single solenoid valves: 4
  - For combination of four sub-bases for double solenoid valves: 8



#### Note

If a single solenoid valve is assembled on a double solenoid valve position, the second address (for coil 12) is also occupied and cannot be used.

## Characteristics – Electrical components

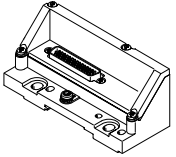
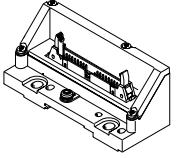
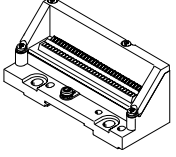
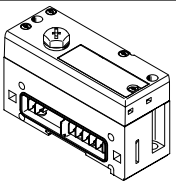
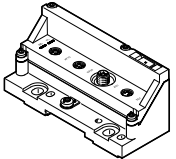
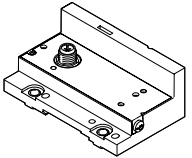
Variants of the left-hand end plate					
Graphical illustration	Code	Type	Max. number of addresses	Degree of protection	Notes
<b>Electrical multi-pin plug connection</b>					
	Electrical connection: MS1	VMPAL-EPL-SD25-IP40	24	IP40	Electrical connection: Sub-D, 25-pin
	Electrical connection: MS2	VMPAL-EPL-SD9-IP40	8	IP40	Electrical connection: Sub-D, 9-pin
	Electrical connection: MS3	VMPAL-EPL-SD44-IP40	32	IP40	Electrical connection: Sub-D, 44-pin
	Electrical connection: MS6	VMPAL-EPL-SD25	24	IP67	Electrical connection: Sub-D, 25-pin
	Electrical connection: MS8	VMPAL-EPL-SD44	32	IP67	Electrical connection: Sub-D, 44-pin
	Electrical connection: MF1	VMPAL-EPL-FL40-IP40	32	IP40	Electrical connection: ribbon cable, 40-pin
	Electrical connection: MC	VMPAL-EPL-KL33-IP40	32	IP40	Electrical connection: terminal strip, 33-pin
<b>Fieldbus interface/CPX terminal</b>					
	Electrical connection: CX	VMPAL-EPL-CPX	32	IP67	Electrical connection: CPX linkage
<b>Interface to automation system CPX-AP-I</b>					
	Electrical connection: API	VMPAL-EPL-AP	32	IP65 IP67	Electrical connection <ul style="list-style-type: none"> <li>• 2x socket, M8x1, D-coded, 4-pin, AP-COM</li> <li>• M8x1, A-coded, 4-pin for power supply</li> </ul>
<b>I-Port interface/IO-Link</b>					
	Electrical connection: LK	VMPAL-EPL-IPO32	32	IP65 IP67	Electrical connection: M12, 5-pin, IO-Link
	Electrical connection: PT	VMPAL-EPL-IPO32	32	IP65 IP67	Electrical connection: M12, 5-pin, I-Port interface

## Characteristics – Electrical components

Pin allocation for electrical multi-pin plug connection – Sub-D plug, 9-pin

	Pin	Address/coil	Pin	Address/coil	
	1	0	6	5	- <b>Note</b> The drawing shows the view onto the pins of the Sub-D plug.
	2	1	7	6	
	3	2	8	7	
	4	3	9	0 V <sup>1)</sup>	
	5	4			

1) 0 V with positive-switching control signals; in the case of negative-switching control signals, connect 24 V; mixed operation is not permitted!

Pin allocation for electrical multi-pin plug connection – Sub-D plug, 25-pin

	Pin	Address/coil	Pin	Address/coil	
	1	0	14	13	- <b>Note</b> The drawing shows the view onto the pins of the Sub-D plug.
	2	1	15	14	
	3	2	16	15	
	4	3	17	16	
	5	4	18	17	
	6	5	19	18	
	7	6	20	19	
	8	7	21	20	
	9	8	22	21	
	10	9	23	22	
	11	10	24	23	
	12	11	25	0 V <sup>1)</sup>	
	13	12			



1) 0 V with positive-switching control signals; in the case of negative-switching control signals, connect 24 V; mixed operation is not permitted!

Pin allocation for electrical multi-pin plug connection – Sub-D plug, 44-pin

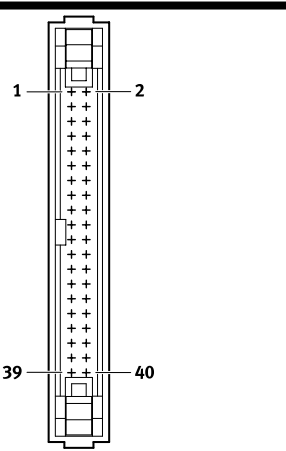

	Pin	Address/coil	Pin	Address/coil	Pin	Address/coil
	1	0	18	17	35	n.c.
	2	1	19	18	36	n.c.
	3	2	20	19	37	n.c.
	4	3	21	20	38	n.c.
	5	4	22	21	39	n.c.
	6	5	23	22	40	n.c.
	7	6	24	23	41	0 V <sup>1)</sup>
	8	7	25	24	42	0 V <sup>1)</sup>
	9	8	26	25	43	0 V <sup>1)</sup>
	10	9	27	26	44	0 V <sup>1)</sup>
	11	10	28	27		
	12	11	29	28		
	13	12	30	29		
	14	13	31	30		
	15	14	32	31		
	16	15	33	n.c.		
	17	16	34	n.c.		

1) 0 V with positive-switching control signals; in the case of negative-switching control signals, connect 24 V; mixed operation is not permitted!

## Characteristics – Electrical components

Pin allocation for electrical multi-pin plug connection – Ribbon cable, 40-pin		Pin	Address/coil	Pin	Address/coil	Pin	Address/coil
	1	0	18	17	35	0 V <sup>1)</sup>	
	2	1	19	18	36	0 V <sup>1)</sup>	
	3	2	20	19	37	0 V <sup>1)</sup>	
	4	3	21	20	38	0 V <sup>1)</sup>	
	5	4	22	21	39	0 V <sup>1)</sup>	
	6	5	23	22	40	0 V <sup>1)</sup>	
	7	6	24	23	<p> <b>Note</b></p> <p>The drawing shows the view onto the pins of the ribbon cable plug. The ribbon cable connection is established using a plug in accordance with DIN EN 60603-13:1998-09 (NECU-FCG40-K). → Internet: necu</p>		
	8	7	25	24			
	9	8	26	25			
	10	9	27	26			
	11	10	28	27			
	12	11	29	28			
	13	12	30	29			
	14	13	31	30			
	15	14	32	31			
	16	15	33	0 V <sup>1)</sup>			
	17	16	34	0 V <sup>1)</sup>			

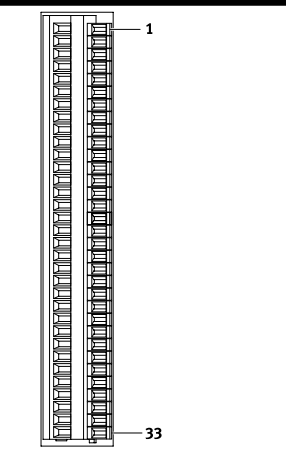
1) 0 V with positive-switching control signals; in the case of negative-switching control signals, connect 24 V; mixed operation is not permitted!

Pin allocation for electrical multi-pin plug connection – Terminal strip, 33-pin		Pin	Address/coil	Pin	Address/coil	Pin	Address/coil
	1	0	16	15	31	30	
	2	1	17	16	32	31	
	3	2	18	17	33	0 V <sup>1)</sup>	
	4	3	19	18	<p> <b>Note</b></p> <p>The drawing shows the view onto the pins of the terminal strip. Cables with the following specifications can be connected:</p> <ul style="list-style-type: none"> <li>Conductor cross section 0.08 ... 0.5 mm<sup>2</sup></li> <li>Stripped insulation 5 ... 6 mm</li> </ul>		
	5	4	20	19			
	6	5	21	20			
	7	6	22	21			
	8	7	23	22			
	9	8	24	23			
	10	9	25	24			
	11	10	26	25			
	12	11	27	26			
	13	12	28	27			
	14	13	29	28			
	15	14	30	29			

1) 0 V with positive-switching control signals; in the case of negative-switching control signals, connect 24 V; mixed operation is not permitted!

## Characteristics – Electrical components

### Fieldbus interface/CPX terminal

All functions and features of the electrical peripherals CPX apply in combination with the CPX interface.

This means the following:

- The valves and outputs are supplied via the system supply for the CPX terminal
- The valves can optionally be actuated or switched off separately from the outputs

The pneumatic interface (left-hand end plate) serves as an adapter between the two current feeds.

In the pneumatic interface, the serial signals from the CPX terminal are converted into parallel signals.

The number of addresses (solenoid coils that can be connected) is set in the range 4 ... 32 solenoid coils via a selector (rotary switch) on the pneumatic interface. The default setting upon delivery provides 32 addresses. This enables extensions to be pre-assigned in a control program and called up by manual settings.

After converting or extending the valve terminal, the number of output addresses occupied by the pneumatic components must be checked and if applicable adjusted on the pneumatic interface.



**Note**

More information can be found at:  
→ Internet: cpx

### Automation system CPX-AP-I

All functions and features of the CPX-AP-I apply in combination with the automation system CPX-AP-I:

- Power supply via the connection in the left-hand end plate of the MPA-L

- Power supply together with other modules or individually for the valve terminal
- Valves actuated via the communication cable from the preceding module

- Up to 50 m cable length between the modules
- Up to 80 individual modules/valve terminals per bus interface



**Note**

More information can be found at:  
→ Internet: cpx-ap-i

### I-Port interface/IO-Link

The I-Port interface/IO-Link enables the valve terminal CPV to be connected to the following systems:

- I-Port Master from Festo (CPX terminal)
- Bus node CTEU from Festo
- IO-Link Master

The maximum distance between the I-Port/IO-Link Master and valve terminal with I-Port interface/IO-Link is 20 m.

The 5-pin connecting cables contain the power supply for the valves; separate from this is the power supply for

the internal valve terminal electronics and the control signals.



**Note**

More information can be found at:  
→ Internet: cteu

#### I-Port interface/IO-Link pin allocation

	Pin	Designation
	1	24 V DC supply voltage for electronics and inputs
	2	24 V DC load voltage supply for valves and outputs
	3	0 V DC supply voltage for electronics and sensors
	4	Communication signal C/Q, data transmission line
	5	0 V DC load voltage supply for valves and outputs

## Characteristics – Electrical components

### Instructions for use

#### Operating medium

Operate your system with unlubricated compressed air if possible. Festo valves and cylinders are designed so that, if used as intended, they will not require additional lubrication and will still achieve a long service life. The quality of compressed air downstream of the compressor must correspond to that of unlubricated compressed air. If possible, do not operate the entire system with lubricated compressed air. The lubricators should, where possible, always be installed directly upstream of the actuator requiring them.

Incorrect additional oil and too high an oil content in the compressed air reduce the service life of the valve terminal.

Use Festo special oil OFSW-32 or the alternatives listed in the Festo catalogue (as specified in DIN 51524 HLP32; basic oil viscosity 32 CST at 40°C).

#### Bio-oils



When using bio-oils (oils which are based on synthetic or native ester, e.g. rapeseed oil methyl ester), the maximum residual oil content of 0.1 mg/m<sup>3</sup> must not be exceeded (see ISO 8573-1 Class 2).

#### Mineral oils

When using mineral oils (e.g. HLP oils to DIN 51524, parts 1 to 3) or similar oils based on poly-alpha-olefins (PAO), the maximum residual oil content of 5 mg/m<sup>3</sup> must not be exceeded (see ISO 8573-1 Class 4).

A higher residual oil content is not permitted, regardless of the compressor oil, because the permanent lubrication would otherwise be flushed out over a period of time.

Data sheet

-  - Flow rate  
up to 870 l/min
  
-  - Width of valves  
10 mm  
14 mm  
20 mm
  
-  - Voltage  
24 V DC

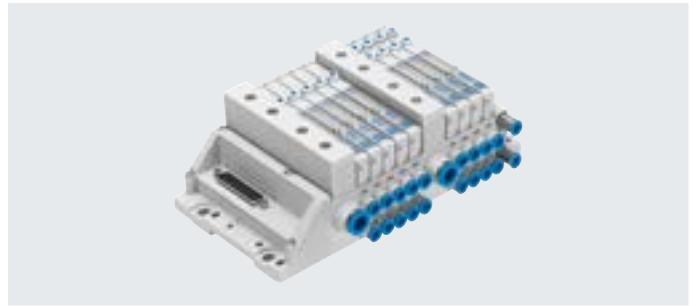

General technical data	
Valve terminal composition	Valve sizes can be mixed
Electrical actuation	Fieldbus      Multi-pin plug      IO-Link      I-Port
Electric I/O system	Yes
Actuation type	Electrical
Type of control	Electrical
Nominal operating voltage [V DC]	24
Permissible voltage fluctuations [%]	±25
Max. no. of valve positions	32
Max. no. of pressure zones	20
Valve size [mm]	10, 14, 20
Signal status indication	LED
Switching position indication	LED
Pilot air supply	Internal or external
Suitable for vacuum	Yes
Mounting position	Any
Manual override	Non-detenting, detenting
Corrosion resistance class CRC <sup>1)</sup>	3
Note on materials	RoHS-compliant
Degree of protection	IP65, IP67

1) Corrosion resistance class CRC 3 to Festo standard FN 940070  
High corrosion stress. Outdoor exposure under moderate corrosive conditions. Externally visible parts with primarily functional surface requirements which are in direct contact with a normal industrial environment.

Operating and environmental conditions	
Operating medium	Compressed air to ISO 8573-1:2010 [7:4:4] → 37
Note on the operating/pilot medium	Lubricated operation possible (in which case lubricated operation will always be required)
Operating pressure [MPa]	-0.09 ... +1
[bar]	-0.9 ... +10
Ambient temperature [°C]	-5 ... +50
Temperature of medium [°C]	-5 ... +50
Storage temperature <sup>1)</sup> [°C]	-20 ... +40
CE marking (see declaration of conformity)	To EU EMC Directive <sup>2)</sup> To EU RoHS Directive <sup>2)</sup>
UKCA marking (see declaration of conformity)	To UK instructions for EMC <sup>2)</sup> To UK RoHS instructions <sup>2)</sup>
PWS conformity	VDMA24364-B1/B2-L
Certification	cUL us listed (OL) RCM compliance mark

1) Long-term storage  
2) For information about the area of use, see the EC declaration of conformity at: [www.festo.com/catalogue/...](http://www.festo.com/catalogue/...) → Support/Downloads.  
If the devices are subject to usage restrictions in residential, commercial or light-industrial environments, further measures for the reduction of the emitted interference may be necessary.



## Data sheet

Technical data – Valve width 10 mm															
Code for position function 1-32		M	J	N	K	H	B	G	E	X	W	D	I		
Design		Piston spool valve													
Sealing principle		Soft													
Overlap		Positive overlap													
Flow direction		Reversible			Non-reversible			Reversible			Reversible		Non-reversible		
Reset method		Pneumatic spring		–		Pneumatic spring			Mechanical spring			Pneumatic spring			
Switching times		On	[ms]	10	10	10	10	10	10	10	10	10	10	8	
		Off	[ms]	20	–	20	20	20	35	35	35	20	20	20	20
		Change-over	[ms]	–	15	–	–	–	15	15	15	–	–	–	–
Standard nominal flow rate		[l/min]	360	360	300	230	300	300	320	240	255	255	230	260	
Standard nominal flow rate with QS-6		[l/min]	360	360	300	230	300	300	320	240	255	255	230	260	
Operating pressure		[MPa]	–0.09 ... +1		0.3 ... 1			–0.09 ... +1			–0.09 ... +1		0.3 ... 1		
		[bar]	–0.9 ... +10		3 ... 10			–0.9 ... +10			–0.9 ... +10		3 ... 10		
Pilot pressure		[MPa]	0.3 ... 0.8												
		[bar]	3 ... 8												
Max. tightening torque for valve mounting		[Nm]	0.25												
Corrosion resistance class CRC <sup>1)</sup>		1													
Materials		Die-cast aluminium													
Product weight		[g]	49	56	56	56	56	56	56	56	49	49	56	56	

1) Corrosion resistance class CRC 1 to Festo standard FN 940070

Low corrosion stress. Dry indoor application or transport and storage protection. Also applies to parts behind coverings, in the non-visible interior area, and parts which are covered in the application (e.g. drive trunnions).

Technical data – Valve width 10 mm												
Code for position function 1-32		MS	NS	KS	HS	DS	MU	NU	KU	HU		
Design		Piston spool valve					Poppet valve with return spring					
Sealing principle		Soft					Soft					
Overlap		Overlap					Underlap					
Flow direction		Reversible					Reversible					
Reset method		Mechanical spring					Mechanical spring					
Switching times		On	[ms]	14	14	14	14	10	10	8	10	
		Off	[ms]	27	16	16	16	14	8	10	10	
		Change-over	[ms]	–	–	–	–	–	–	–	–	
Maximum switching frequency		[Hz]	2	–	–	–	–	–	–	–	–	
Standard nominal flow rate		[l/min]	360	300	230	300	230	140 ... 190	190	160	140 ... 190	
Standard nominal flow rate with QS-6		[l/min]	360	300	230	300	230	140 ... 190	190	160	140 ... 190	
Note on standard nominal flow rate		–					1 → 2: 190 l/min 1 → 4: 140 l/min		–		1 → 2: 190 l/min 1 → 4: 140 l/min	
Operating pressure		[MPa]	–0.09 ... +0.8					–0.09 ... +1				
		[bar]	–0.9 ... +8					–0.9 ... +10				
Pilot pressure		[MPa]	0.3 ... 0.8					0.4 ... 0.8				
		[bar]	3 ... 8					4 ... 8				
Max. tightening torque for valve mounting		[Nm]	0.25					0.25				
Corrosion resistance class CRC <sup>1)</sup>		1					3					
Materials		Die-cast aluminium					Reinforced PPA					
Product weight		[g]	56				35	42	42	42		

1) Corrosion resistance class CRC 1 to Festo standard FN 940070

Low corrosion stress. Dry indoor application or transport and storage protection. Also applies to parts behind coverings, in the non-visible interior area, and parts which are covered in the application (e.g. drive trunnions).

Corrosion resistance class CRC 3 to Festo standard FN 940070

High corrosion stress. Outdoor exposure under moderate corrosive conditions. Externally visible parts with primarily functional surface requirements which are in direct contact with a normal industrial environment.

Data sheet

Technical data – Valve width 14 mm		M	J	N	K	H	B	G	E	
Code for position function 1-32										
Design		Piston spool valve								
Sealing principle		Soft								
Overlap		Positive overlap								
Flow direction		Reversible			Non-reversible		Reversible			
Reset method		Pneumatic spring					Mechanical spring			
Switching times	On [ms]	13	9	9	10	10	12	10	12	
	Off [ms]	30	–	28	28	26	40	40	40	
	Change-over [ms]	–	24	–	–	–	18	20	18	
Standard nominal flow rate	[l/min]	550 ... 670	550 ... 670	550 ... 650	550 ... 600	550 ... 650	550 ... 630	500 ... 610	420 ... 480	
Standard nominal flow rate with QS-8	[l/min]	550 ... 720	550 ... 670	550 ... 730	550 ... 760	550 ... 730	550 ... 690	500 ... 660	420 ... 550	
Note on standard nominal flow rate	[l/min]	MPA-S: 550	MPA-S: 550	MPA-S: 550	MPA-S: 550	MPA-S: 550	MPA-S: 550	MPA-S: 500	MPA-S: 420	
	[l/min]	MPA-L: 670	MPA-L: 670	MPA-L: 650	MPA-L: 600	MPA-L: 650	MPA-L: 630	MPA-L: 610	MPA-L: 480	
Operating pressure	[MPa]	–0.09 ... +1		0.3 ... 1		–0.09 ... +1				
	[bar]	–0.9 ... +10		3 ... 10		–0.9 ... +10				
Pilot pressure	[MPa]	0.3 ... 0.8								
	[bar]	3 ... 8								
Max. tightening torque for valve mounting	[Nm]	0.65								
Corrosion resistance class CRC <sup>1)</sup>		1								
Materials		Die-cast aluminium								
Product weight	[g]	77								

1) Corrosion resistance class CRC 1 to Festo standard FN 940070  
 Low corrosion stress. Dry indoor application or transport and storage protection. Also applies to parts behind coverings, in the non-visible interior area, and parts which are covered in the application (e.g. drive trunnions).

Technical data – Valve width 14 mm		X	W	D	I	MS	NS	KS	HS	DS	
Code for position function 1-32											
Design		Piston spool valve									
Sealing principle		Soft									
Overlap		Positive overlap									
Flow direction		Reversible			Non-reversible		Reversible				
Reset method		Pneumatic spring					Mechanical spring				
Switching times	On [ms]	12	12	9	10	13	12	12	12	10	
	Off [ms]	20	20	26	28	41	20	20	23	20	
	Change-over [ms]	–	–	–	–	–	–	–	–	–	
Maximum switching frequency	[Hz]	–	–	–	–	2	–	–	–	–	
Standard nominal flow rate	[l/min]	360 ... 400	300 ... 340	550 ... 650	550 ... 670	550 ... 670	470 ... 520	470 ... 560	470 ... 520	500 ... 570	
Standard nominal flow rate with QS-8	[l/min]	360 ... 510	300 ... 450	550 ... 720	550 ... 730	550 ... 730	470 ... 550	470 ... 600	470 ... 550	500 ... 570	
Note on standard nominal flow rate	[l/min]	MPA-S: 360	MPA-S: 340	MPA-S: 550	MPA-S: 550	MPA-S: 550	MPA-S: 470	MPA-S: 470	MPA-S: 470	MPA-S: 500	
	[l/min]	MPA-L: 400	MPA-L: 300	MPA-L: 650	MPA-L: 670	MPA-L: 670	MPA-L: 520	MPA-L: 560	MPA-L: 520	MPA-L: 570	
Operating pressure	[MPa]	–0.09 ... +1		0.3 ... 1		–0.09 ... +0.8					
	[bar]	–0.9 ... +10		3 ... 10		–0.9 ... +8					
Pilot pressure	[MPa]	0.3 ... 0.8									
	[bar]	3 ... 8									
Max. tightening torque for valve mounting	[Nm]	0.65				0.65	0.25				
Corrosion resistance class CRC <sup>1)</sup>		1									
Materials		Die-cast aluminium									
Product weight	[g]	77									

1) Corrosion resistance class CRC 1 to Festo standard FN 940070  
 Low corrosion stress. Dry indoor application or transport and storage protection. Also applies to parts behind coverings, in the non-visible interior area, and parts which are covered in the application (e.g. drive trunnions).

## Data sheet

Technical data – Valve width 20 mm		M	J	N	K	H	B	G	E	
Code for position function 1-32										
Design		Piston spool valve								
Sealing principle		Soft								
Overlap		Positive overlap								
Flow direction		Reversible			Non-reversible			Reversible		
Reset method		Pneumatic spring						Mechanical spring		
Switching times	On [ms]	15	9	8	8	8	11	10	11	
	Off [ms]	28	–	28	28	28	46	40	47	
	Change-over [ms]	–	22	–	–	–	23	21	23	
Standard nominal flow rate	[l/min]	870	860	550 ... 600	500 ... 550	550	550	750	700	
Standard nominal flow rate with QS-8	[l/min]	–	–	550	500	550	450	–	–	
Standard nominal flow rate with QS-10	[l/min]	870	860	600	550	550	550	750	700	
Note on standard nominal flow rate	[l/min]	–	–	MPA-S: 550	MPA-S: 500	–	–	–	–	
	[l/min]	–	–	MPA-L: 600	MPA-L: 550	–	–	–	–	
Operating pressure	[MPa]	–0.09 ... +1			0.3 ... 1			–0.09 ... +1		
	[bar]	–0.9 ... +10			3 ... 10			–0.9 ... +10		
Pilot pressure	[MPa]	0.3 ... 0.8								
	[bar]	3 ... 8								
Max. tightening torque for valve mounting	[Nm]	0.65								
Corrosion resistance class CRC <sup>1)</sup>		1								
Materials		Die-cast aluminium								
Product weight	[g]	100								

1) Corrosion resistance class CRC 1 to Festo standard FN 940070

Low corrosion stress. Dry indoor application or transport and storage protection. Also applies to parts behind coverings, in the non-visible interior area, and parts which are covered in the application (e.g. drive trunnions).

Technical data – Valve width 20 mm		X	W	D	I	MS	NS	KS	HS	DS	
Code for position function 1-32											
Design		Piston spool valve									
Sealing principle		Soft									
Overlap		Positive overlap									
Flow direction		Reversible			Non-reversible			Reversible			
Reset method		Pneumatic spring						Mechanical spring			
Switching times	On [ms]	13	13	7	7	8	12	12	12	12	
	Off [ms]	22	22	25	25	36	25	25	25	25	
	Change-over [ms]	–	–	–	–	–	–	–	–	–	
Maximum switching frequency	[Hz]	–	–	–	–	2	–	–	–	–	
Standard nominal flow rate	[l/min]	350	480	650 ... 840	650 ... 850	670 ... 840	550 ... 580	500	550	650 ... 820	
Standard nominal flow rate with QS-8	[l/min]	–	–	650	650	670	550	500	550	650	
Standard nominal flow rate with QS-10	[l/min]	350	480	840	850	840	580	480	550	820	
Note on standard nominal flow rate	[l/min]	–	–	MPA-S: 650	MPA-S: 650	MPA-S: 670	MPA-S: 550	MPA-S: 500	–	MPA-S: 650	
	[l/min]	–	–	MPA-L: 840	MPA-L: 850	MPA-L: 840	MPA-L: 580	MPA-L: 480	–	MPA-L: 820	
Operating pressure	[MPa]	–0.09 ... +1			0.3 ... 1			–0.09 ... +0.8			
	[bar]	–0.9 ... +10			3 ... 10			–0.9 ... +8			
Pilot pressure	[MPa]	0.3 ... 0.8									
	[bar]	3 ... 8									
Max. tightening torque for valve mounting	[Nm]	0.65									
Corrosion resistance class CRC <sup>1)</sup>		1									
Materials		Die-cast aluminium									
Product weight	[g]	100									

1) Corrosion resistance class CRC 1 to Festo standard FN 940070

Low corrosion stress. Dry indoor application or transport and storage protection. Also applies to parts behind coverings, in the non-visible interior area, and parts which are covered in the application (e.g. drive trunnions).

## Data sheet

Safety data		Valve width 10 mm	Valve width 14 mm	Valve width 20 mm
Max. positive test pulse with logic 0	[μs]	400	400	400
Max. negative test pulse with logic 1	[μs]	200	200	900
Shock resistance	Shock test with severity level 2 to FN 942017-5 and EN 60068-2-27			
Vibration resistance	Transport application test with severity level 2 to FN 942017-4 and EN 60068-2-6			
<b>Pneumatic connections</b>				
<b>Right-hand end plate</b>				
Supply	1	Thread G1/4 (straight or angled push-in fitting, for tubing O.D. 6 mm, 8 mm, 10 mm, 12 mm, 5/16", 3/8")		
Exhaust port	3	Thread G1/4 (straight or angled push-in fitting, for tubing O.D. 6 mm, 8 mm, 10 mm, 5/16", 3/8")		
	5	Thread G1/4 (straight or angled push-in fitting, for tubing O.D. 6 mm, 8 mm, 10 mm, 5/16", 3/8")		
Pilot air supply	12/14	Thread M7 (straight or angled push-in fitting, for tubing O.D. 4 mm, 6 mm; straight push-in fitting, for tubing O.D. 3/16", 1/4")		
Pilot exhaust air	82/84	Thread M7 (straight or angled push-in fitting, for tubing O.D. 4 mm, 6 mm; straight push-in fitting, for tubing O.D. 3/16", 1/4")		
<b>Supply module with exhaust plate</b>				
Supply	1	Cartridge 20 mm (straight cartridge, for tubing O.D. 8 mm, 10 mm, 12 mm, 5/16", 3/8", 1/2", adapter for thread G1/4), flat plate silencer		
Exhaust port	3/5	Cartridge 20 mm (straight cartridge, for tubing O.D. 8 mm, 10 mm, 12 mm, 5/16", 3/8", 1/2", adapter for thread G1/4), flat plate silencer		
<b>Vertical pressure supply plate, width 20 mm</b>				
Supply	1	Thread G1/8 (straight push-in fitting, for tubing O.D. 8 mm, 10 mm, 5/16", 3/8")		
<b>Sub-base, width 10 mm</b>				
Working ports	2	Cartridge 10 mm (straight or angled cartridge, for tubing O.D. 4 mm, 6 mm, 5/32", 1/4", adapter for thread M7)		
	4	Cartridge 10 mm (straight or angled cartridge, for tubing O.D. 4 mm, 6 mm, 5/32", 1/4", adapter for thread M7)		
<b>Sub-base, width 14 mm</b>				
Working ports	2	Cartridge 14 mm (straight or angled cartridge, for tubing O.D. 6 mm, 8 mm, 1/4", 5/16", adapter for thread G1/8)		
	4	Cartridge 14 mm (straight or angled cartridge, for tubing O.D. 6 mm, 8 mm, 1/4", 5/16", adapter for thread G1/8)		
<b>Sub-base, width 20 mm</b>				
Working ports	2	Cartridge 18 mm (straight or angled cartridge, for tubing O.D. 8 mm, 10 mm, 5/16", 3/8", adapter for thread G1/4)		
	4	Cartridge 18 mm (straight or angled cartridge, for tubing O.D. 8 mm, 10 mm, 5/16", 3/8", adapter for thread G1/4)		

Data sheet

**Pilot pressure p2 as a function of working pressure p1 with external pilot air supply**

For valves with code for position function 1-32: M, J, B, G, E, W, X

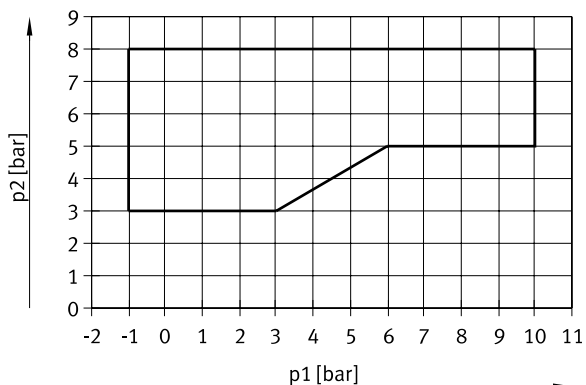

For valves with code for position function 1-32: N, K, H, D, I

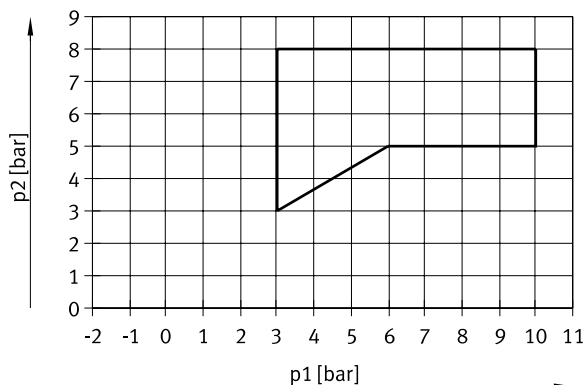

**Pilot pressure p2 as a function of working pressure p1 for valves with mechanical spring return**

For valves in width 10 mm with code for position function 1-32: MS, NS, KS, HS, DS

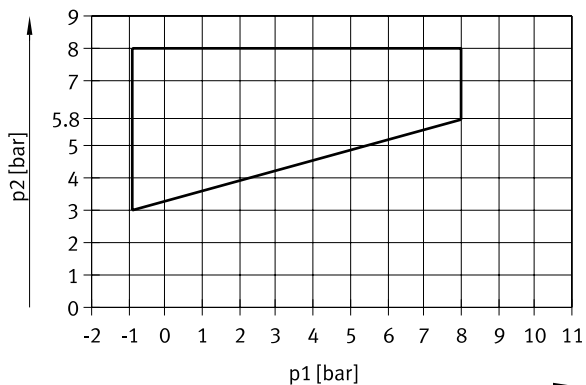

For valves in width 14 mm with code for position function 1-32: MS, NS, KS, HS, DS

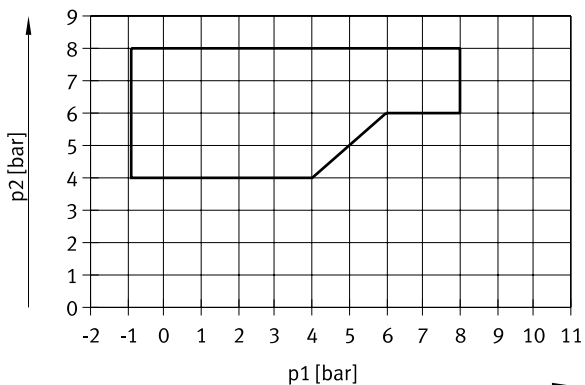

For valves in width 20 mm with code for position function 1-32: MS, NS, KS, HS, DS

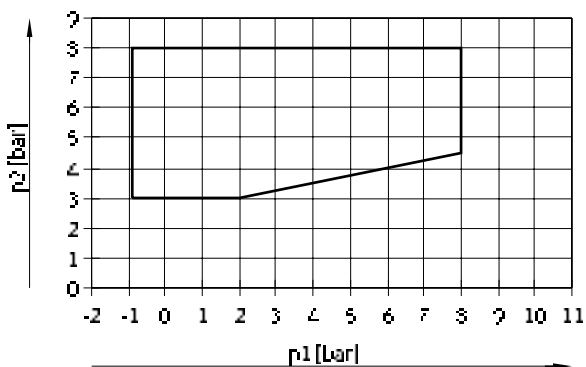

For valves in width 10 mm with code for position function 1-32: MU, NU, KU, HU

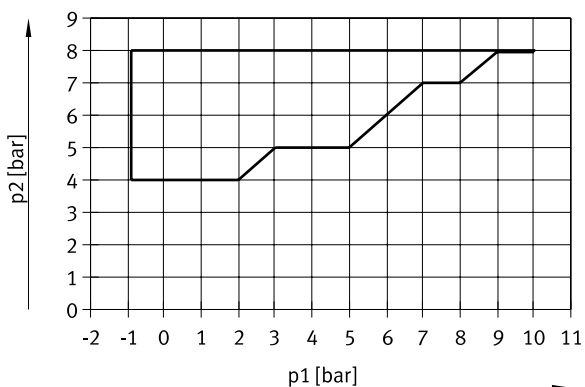

## Data sheet

### Current consumption per solenoid coil at nominal voltage

		Width		
		10 mm	14 mm	20 mm
Nominal pick-up current	[mA]	50	50	110
Nominal current with current reduction	[mA]	10	10	23
Time until current reduction	[ms]	20	20	20

### Electrical data – MPA-L with electrical interface for CPX terminal

Intrinsic current consumption of the valve terminal (internal electronics, without valves)		
At 24 V U <sub>EL/SEN</sub> <sup>1)</sup>	[mA]	Typically 13
At 24 V U <sub>val</sub> <sup>2)</sup>	[mA]	Typically 35
Diagnostic message		
Undervoltage U <sub>OUT</sub> <sup>3)</sup>	[V]	17.7 ... 17.8

- 1) Power supply for electronics and sensors
- 2) Load voltage supply for valves
- 3) Load voltage outside of function range

### Electrical data – MPA-L with electrical interface for automation system CPX-AP-I

Intrinsic current consumption of the valve terminal (internal electronics, without valves)		
At 24 V U <sub>EL/SEN</sub> <sup>1)</sup>	[mA]	Typically 30
At 24 V U <sub>val</sub> <sup>2)</sup>	[mA]	Typically 15

- 1) Power supply for electronics and sensors
- 2) Load voltage supply for valves

### Electrical data – MPA-L with I-Port interface/IO-Link

Intrinsic current consumption of the valve terminal (internal electronics, without valves)		
Operating voltage	[mA]	30
Load voltage	[mA]	30

### Materials

Sub-base	PA
Supply module	PPA
End plate	Die-cast aluminium, PA, PBT
Seals	NBR
Exhaust plate	PA
Flat plate silencer	PE
Electrical manifold module	PBT, PA, copper alloy
Pressure regulator plate	PA
Vertical pressure shut-off plate	Reinforced PA, wrought aluminium alloy
Vertical pressure supply plate	Reinforced PA
Tie rod	High-alloy stainless steel

## Data sheet

Product weight [g]	
CPX module (complete)	Approx. 210
Left-hand end plate with interface to automation system CPX-AP-I	194
Left-hand end plate, multi-pin plug, Sub-D, 44-pin	130
Left-hand end plate, I-Port interface/IO-Link	170
Supply module with electrical manifold module, without cartridge	64
Supply module with electrical manifold module, with cartridge	70
Right-hand end plate without supply ports	105
Right-hand end plate with supply ports	160
Valve	→ 39
M4 screw for tie rod <sup>1)</sup>	3
M3 screw for linking four sub-bases <sup>2)</sup>	70
Sleeve <sup>1)</sup> , internal hexagon 4 mm	18/24/27/33 (36/46/56/66 mm for tie rod)
Tie rod extender <sup>1)</sup>	23/31/46 (for extending the valve terminal by one sub-base with a width of 10/14/20 mm) 279/387 (for extending the valve terminal by four sub-bases with a width of 10/14 mm)
Plate for ducted exhaust air/flat plate silencer	36/40
QSM-M7-4-I	4
QSM-M7-6-I	5
QS-G1/4-8-I	22
QS-G1/4-10-I	23
QSPKG10-3	1.5
QSPKG10-4	1.4
QSPKG10-6	1.8
QSPKG20-8	6
QSPKG20-10	9
QSPKG20-12	13

1) Weight for a pack of 3

2) Weight for a pack of 10

Product weight [g]	Width		
	10 mm	14 mm	20 mm
Black sub-base (with seal, light guide)	21	33	47
Electrical manifold module for one sub-base	9	9	14
Electrical manifold module for combination of four sub-bases	29	29	–
Per vacant position L	20	40	45
Pressure regulator plate	74	76	180
Vertical pressure shut-off plate	60	240	–
Vertical pressure supply plate	–	30	70

## Product weight – Threaded rod for tie rod

Length [mm]	5	45	85	125	165	205	245	285	325	365	405	445	485	525	565	605	645
Product weight <sup>1)</sup> [g]	6	33	60	60	114	141	168	192	219	246	273	300	327	354	378	405	432
Length [mm]	685	725	765	805													
Product weight <sup>1)</sup> [g]	459	483	513	540													

1) Weight for a pack of 3

Data sheet

Dimensions

Download CAD data → [www.festo.com](http://www.festo.com)

Valve terminal with multi-pin plug connection

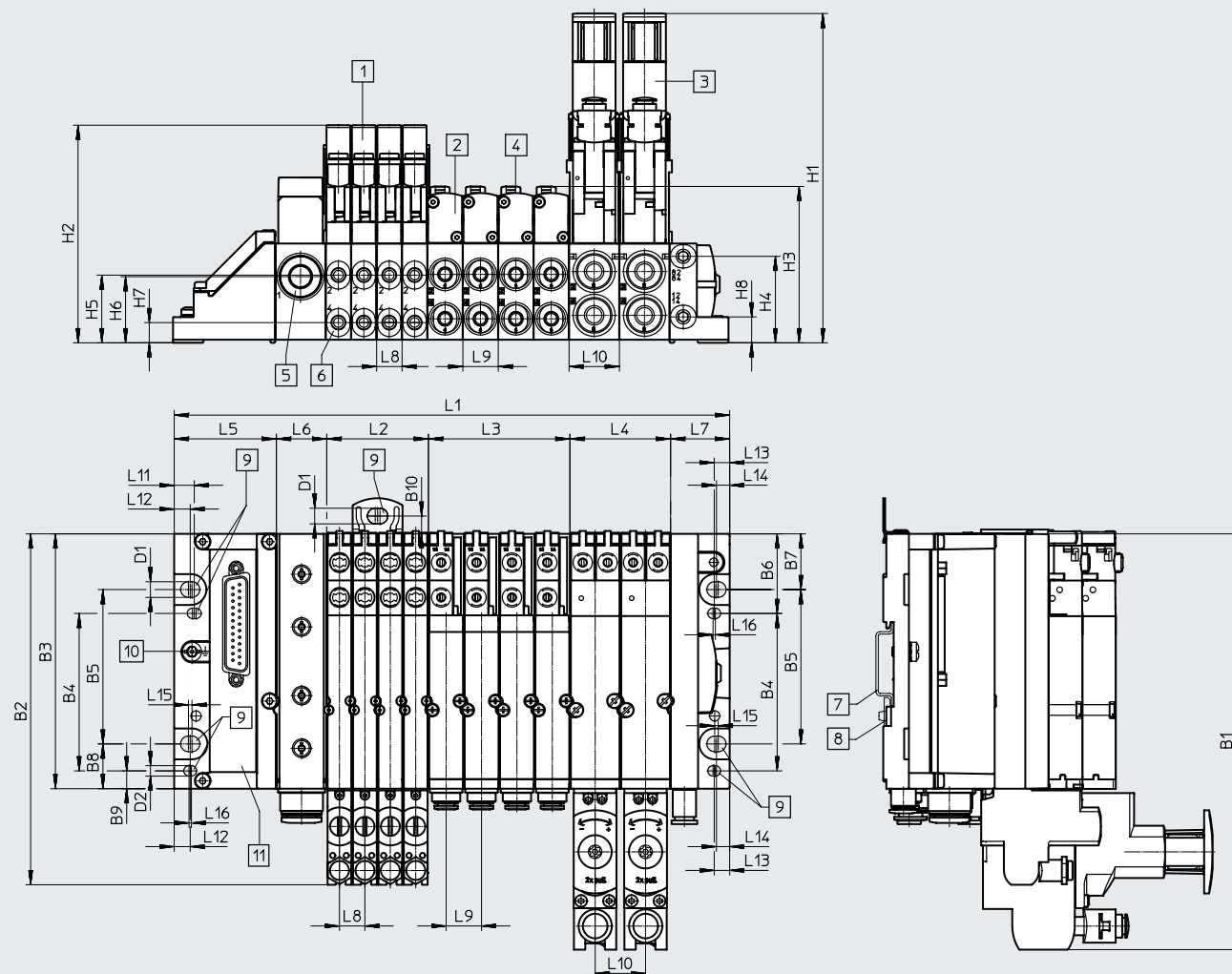

- [1] Solenoid valve VMPA1
- [2] Solenoid valve VMPA14
- [3] Solenoid valve VMPA2
- [4] Manual override
- [5] Supply module
- [6] Working ports
- [7] H-rail
- [8] H-rail mounting
- [9] Mounting holes
- [10] Earthing screw
- [11] Multi-pin plug connection

Type	L1 <sup>1)</sup>	L2 <sup>1)</sup>	L3 <sup>1)</sup>	L4 <sup>1)</sup>	L5	L6	L7	L8	L9	L10	L11	L12	L13	L14	L15	L16
MPA-L	89.1 + L2 + L3 + L4	m x 10.7	n x 14.9	o x 21.2	43	21.2	24.9	10.7	14.9	21.2	8.5	6.8	6.5	5.6	1.5	1

Type	B1	B2	B3	B4	B5	B6	B7	B8	B9	B10
MPA-L	175.1	147.8	107.3	66.3	65	33.5	23.5	18.9	7.5	7.5

Type	D1	D2	H1	H2	H3	H4	H5	H6	H7	H8
MPA-L	6.6	4.4	138.7	92.6	65.7	36.4	28.5	7.9	8.5	10.9

1) m, n, o = number of sub-bases/valve positions (m = width 10 mm, n = width 14 mm, o = width 20 mm)



Data sheet

Dimensions – Hood for multi-pin plug connection

Download CAD data → [www.festo.com](http://www.festo.com)

Cable outlet to front

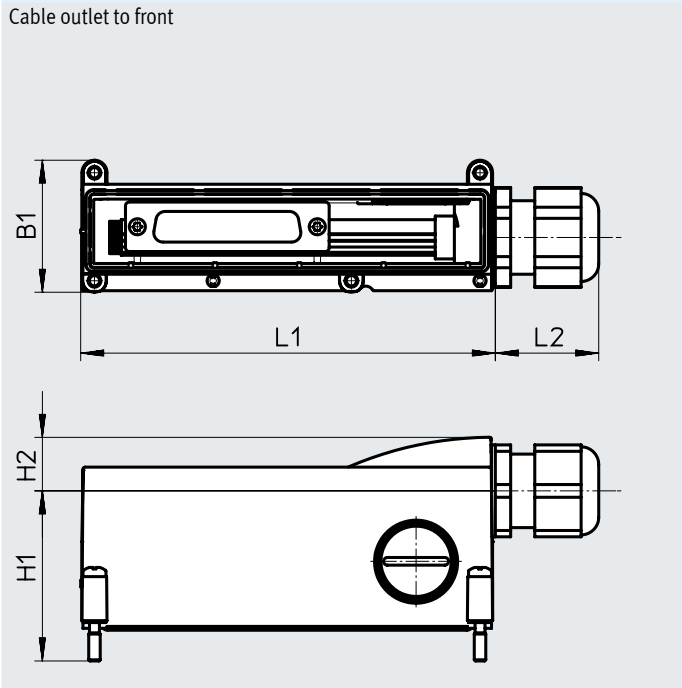

Cable outlet to side

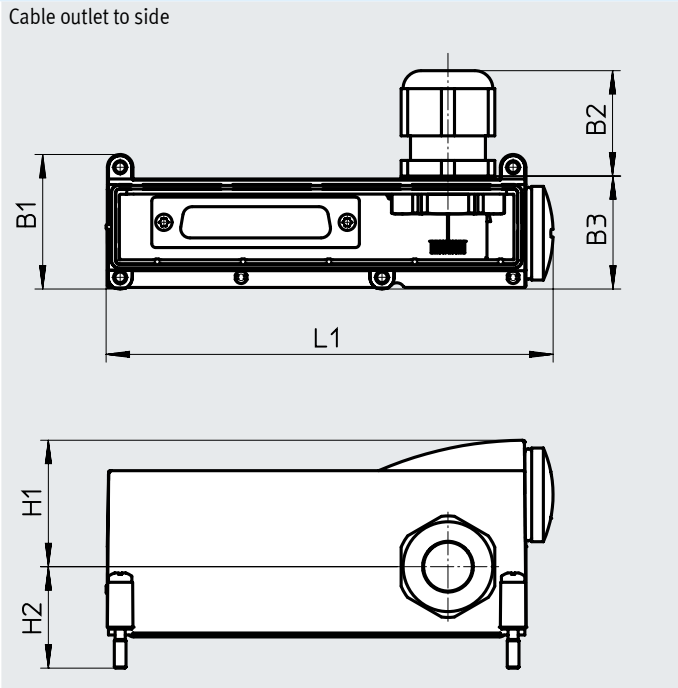

Type	L1	L2	H1	H2	B1	B2	B3
Cable outlet to front	108.3	27	44.4	14	34.5	-	-
Cable outlet to side	114.5	-	32.4	26	34.5	27	29

Data sheet

Dimensions

Download CAD data → [www.festo.com](http://www.festo.com)

Valve terminal with fieldbus interface

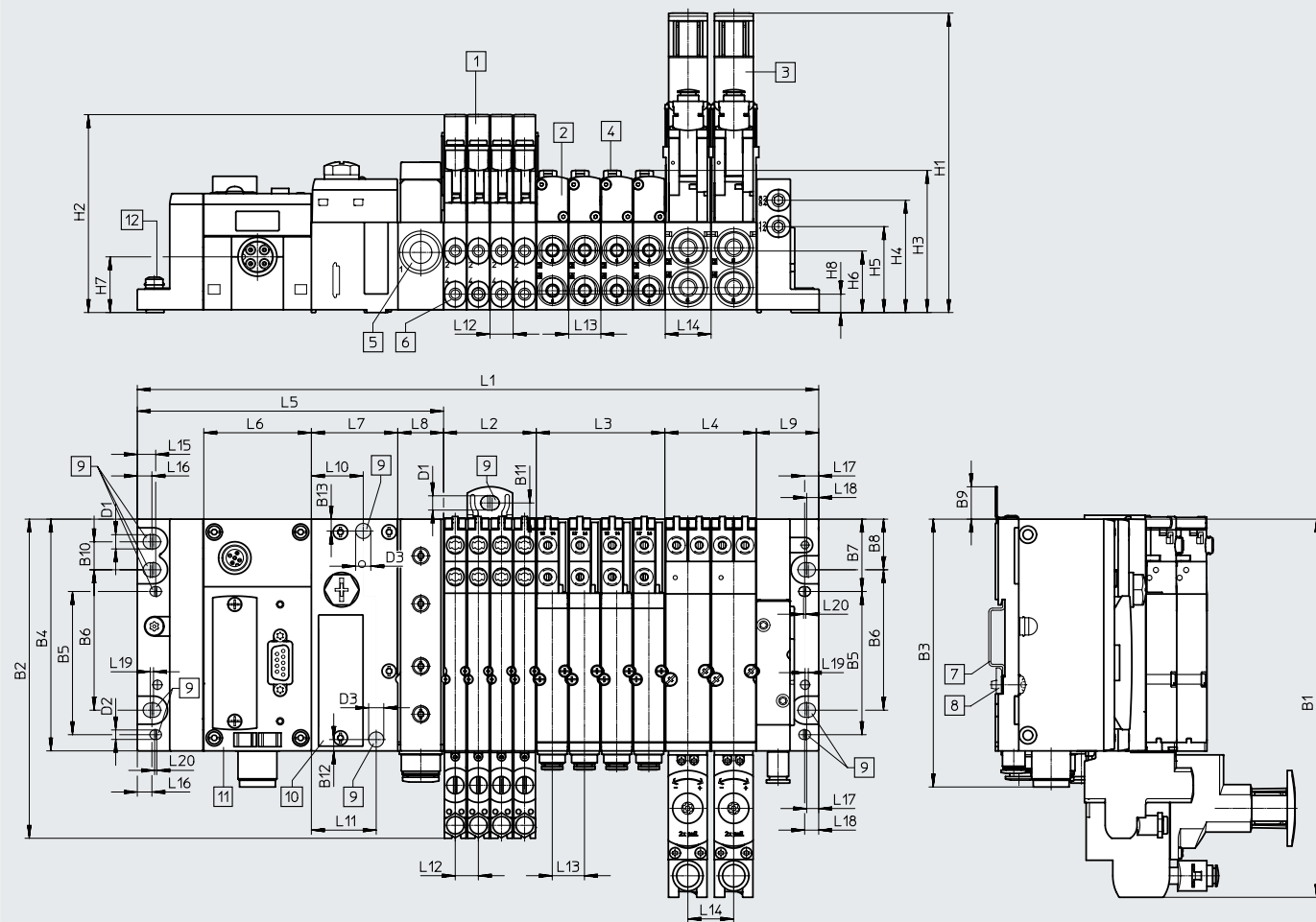

- [1] Solenoid valve VMPA1
- [2] Solenoid valve VMPA14
- [3] Solenoid valve VMPA2
- [4] Manual override
- [5] Supply module
- [6] Working ports
- [7] H-rail
- [8] H-rail mounting
- [9] Mounting holes
- [10] Pneumatic interface, CPX terminal
- [11] CPX module
- [12] Earthing screw

Type	L1 <sup>1)</sup>	L2 <sup>1)</sup>	L3 <sup>1)</sup>	L4 <sup>1)</sup>	L5	L6	L7	L8	L9
MPA-L	170.65 + L2 + L3 + L4	m x 10.7	n x 14.9	o x 21.2	142	50	40.1	21.2	28.8

Type	L10	L11	L12	L13	L14	L15	L16	L17	L18	L19	L20
MPA-L	24	30	10.7	14.9	21.2	8.5	6.75	5.55	6.5	1.5	1

Type	B1	B2	B3	B4	B5	B6	B7	B8	B9	B10	B11	B12	B13
MPA-L	175.1	147.8	124	107.3	66.3	65	33.5	23.45	15	12.95	7.5	5.25	5.5

Type	D1	D2	D3	H1	H2	H3	H4	H5	H6	H7	H8
MPA-L	6.6	4.4	7	138.7	92.6	65.7	52	39.8	28.5	25.8	8.5

1) m, n, o = number of sub-bases/valve positions (m = width 10 mm, n = width 14 mm, o = width 20 mm)

Data sheet

Dimensions

Download CAD data → [www.festo.com](http://www.festo.com)

Valve terminal with interface to automation system CPX-AP-I

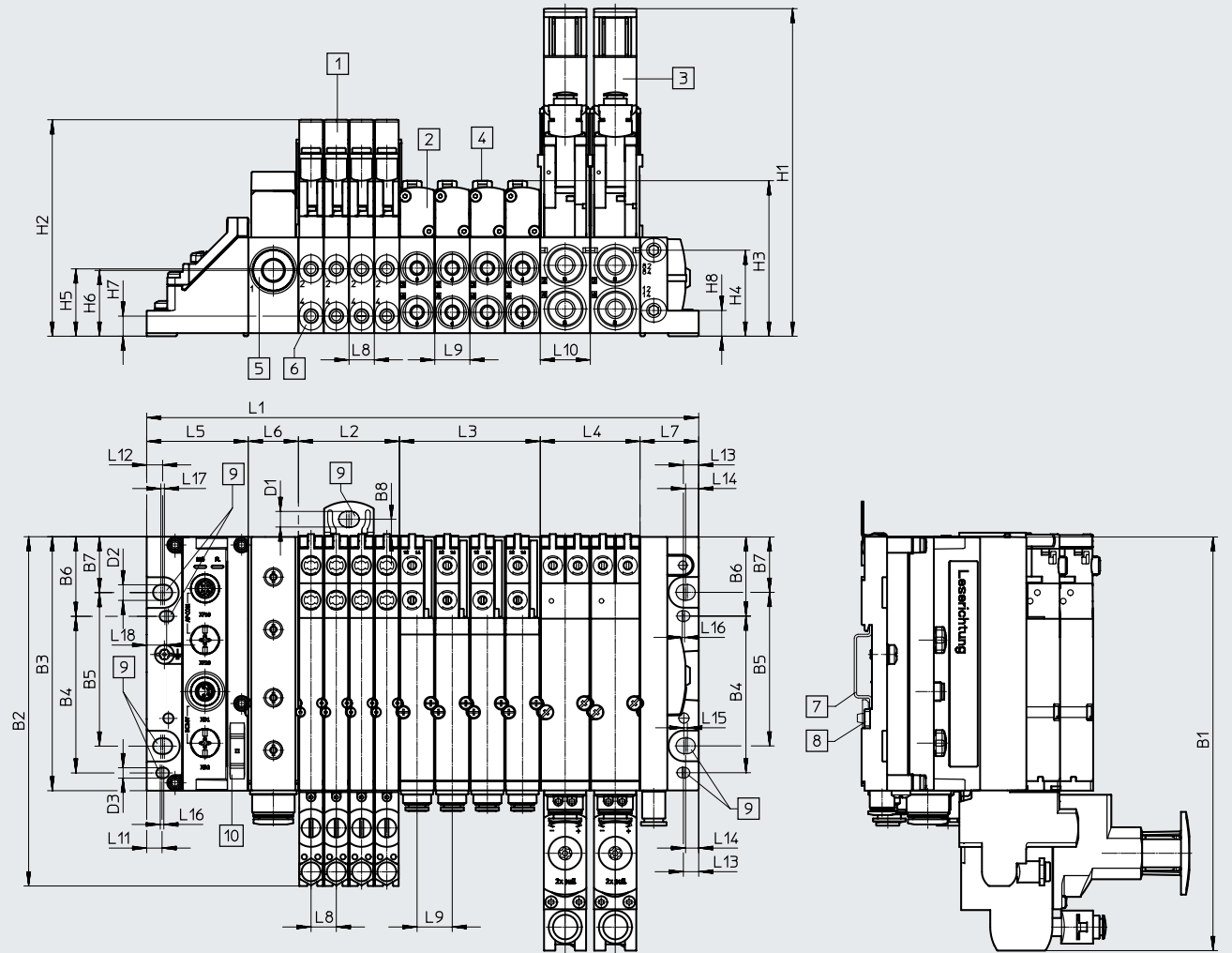

- [1] Solenoid valve VMPA1
- [2] Solenoid valve VMPA14
- [3] Solenoid valve VMPA2
- [4] Manual override
- [5] Supply module
- [6] Working ports
- [7] H-rail
- [8] H-rail mounting
- [9] Mounting holes
- [10] Left-hand end plate with CPX-AP-I interface

Type	B1	B2	B3	B4	B5	B6	B7	B8	D1	D2	D3	H1	H2	H3	H4	H5	H6	H7	H8
MPA-L	175	147.8	107.3	66.3	65	33.7	23.7	18.9	6.6	6.6	4.4	138.7	92.6	65.7	36.4	28.5	27.9	8.5	10.9

Type	L1 <sup>1)</sup>	L2 <sup>1)</sup>	L3 <sup>1)</sup>	L4 <sup>1)</sup>	L5	L6	L7	L8	L9	L10	L11	L12	L13	L14	L15	L16	L17	L18
MPA-L	89.1 + L2 + L3 + L4	m x 10.7	n x 14.9	o x 21.2	43	21.2	24.9	10.7	14.9	21.2	6.5	6.8	6.5	5.6	1.5	1.5	1.5	8.5

1) m, n, o = number of sub-bases/valve positions (m = width 10 mm, n = width 14 mm, o = width 20 mm)

Data sheet

Dimensions

Download CAD data → [www.festo.com](http://www.festo.com)

Valve terminal with I-Port interface/IO-Link

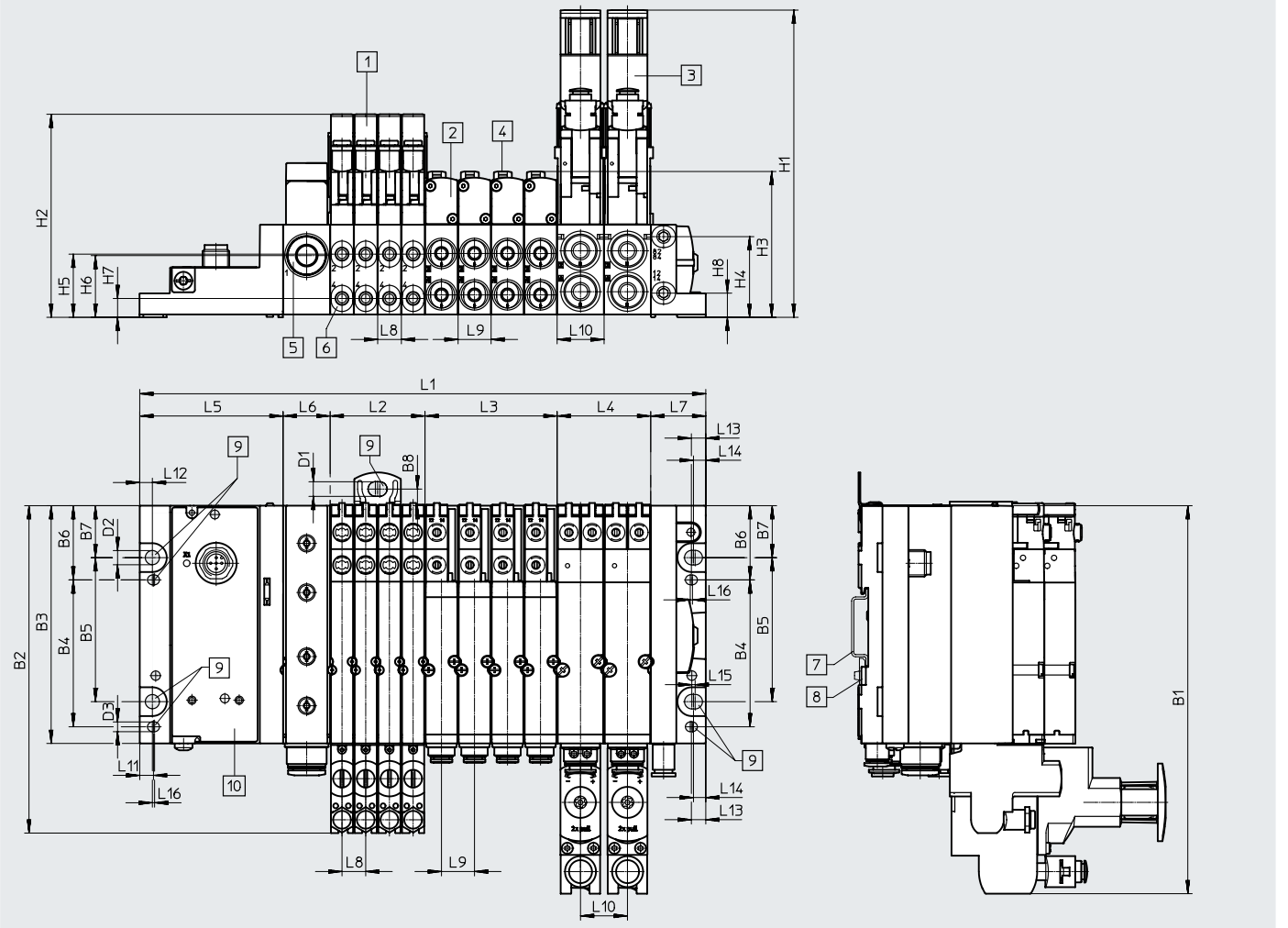

- [1] Solenoid valve VMPA1
- [2] Solenoid valve VMPA14
- [3] Solenoid valve VMPA2
- [4] Manual override
- [5] Supply module
- [6] Working ports
- [7] H-rail
- [8] H-rail mounting
- [9] Mounting holes
- [10] Left-hand end plate with I-Port interface/IO-Link

Type	B1	B2	B3	B4	B5	B6	B7	B8	D1	D2	D3	H1	H2	H3	H4	H5	H6	H7	H8
MPA-L	175.1	147.8	107.3	66.3	65	33.5	23.5	18.9	6.6	6.4	4.5	138.7	92.6	65.7	36.4	28.5	27.9	8.5	10.9



Type	L1 <sup>1)</sup>	L2 <sup>1)</sup>	L3 <sup>1)</sup>	L4 <sup>1)</sup>	L5	L6	L7	L8	L9	L10	L11	L12	L13	L14	L15	L16
MPA-L	110.9 + L2 + L3 + L4	m x 10.7	n x 14.9	o x 21.2	64.8	21.2	24.9	10.7	14.9	21.2	6.2	5.7	6.5	5.6	1.5	1

1) m, n, o = number of sub-bases/valve positions (m = width 10 mm, n = width 14 mm, o = width 20 mm)

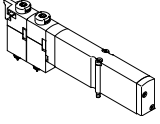
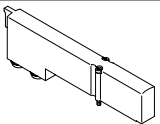

## Accessories

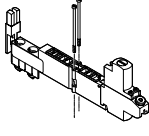
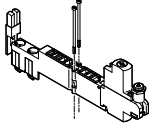
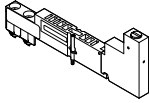
Ordering data		Code	Valve function	Part no.	Type
<b>Individual solenoid valve – Width 10 mm</b>					
	<b>5/2-way valve</b>				
	Position function 1-32: M	Single solenoid	533342	VMPA1-M1H-M-PI	
	Position function 1-32: MS	Single solenoid, mechanical spring return	571334	VMPA1-M1H-MS-PI	
	Position function 1-32: MU	Polymer poppet valve, single solenoid, mechanical spring return	553113	VMPA1-M1H-MU-PI	
	Position function 1-32: J	Double solenoid	533343	VMPA1-M1H-J-PI	
	<b>2x 3/2-way valve</b>				
	Position function 1-32: N	Normally open	533348	VMPA1-M1H-N-PI	
	Position function 1-32: NS	Normally open, mechanical spring return	556839	VMPA1-M1H-NS-PI	
	Position function 1-32: NU	Polymer poppet valve, normally open, mechanical spring return	553111	VMPA1-M1H-NU-PI	
	Position function 1-32: K	Normally closed	533347	VMPA1-M1H-K-PI	
	Position function 1-32: KS	Normally closed, mechanical spring return	556838	VMPA1-M1H-KS-PI	
	Position function 1-32: KU	Polymer poppet valve, normally closed, mechanical spring return	553110	VMPA1-M1H-KU-PI	
	Position function 1-32: H	1x normally open, 1x normally closed	533349	VMPA1-M1H-H-PI	
	Position function 1-32: HS	1x normally open, 1x normally closed, mechanical spring return	556840	VMPA1-M1H-HS-PI	
	Position function 1-32: HU	Polymer poppet valve, 1x normally open, 1x normally closed, mechanical spring return	553112	VMPA1-M1H-HU-PI	
	<b>5/3-way valve</b>				
	Position function 1-32: B	Mid-position pressurised	533344	VMPA1-M1H-B-PI	
	Position function 1-32: G	Mid-position closed	533345	VMPA1-M1H-G-PI	
	Position function 1-32: E	Mid-position exhausted	533346	VMPA1-M1H-E-PI	
	<b>1x 3/2-way valve</b>				
	Position function 1-32: W	Normally open, external compressed air supply	540050	VMPA1-M1H-W-PI	
	Position function 1-32: X	Normally closed, external compressed air supply	534415	VMPA1-M1H-X-PI	
	<b>2x 2/2-way valve</b>				
Position function 1-32: D	Normally closed	533350	VMPA1-M1H-D-PI		
Position function 1-32: DS	Normally closed, mechanical spring return	556841	VMPA1-M1H-DS-PI		
Position function 1-32: I	1x normally closed, 1x normally closed, reversible only	543605	VMPA1-M1H-I-PI		
<b>Vacant position – Installation width 10 mm</b>					
	Position function 1-32: L	Cover plate for a valve position in width 10 mm A self-adhesive label is supplied.	533351	VMPA1-RP	

Accessories

Ordering data		Code	Description	Part no.	Type	
<b>Vertical stacking modules – Width 10 mm</b>						
	Pressure regulator 1-32: PF	Pressure regulator plate with fixed threaded connection M5	For port 1	0.5 ... 6 bar	564911	VMPA1-B8-R1-M5-06
	Pressure regulator 1-32: PA			0.5 ... 8.5 bar	564908	VMPA1-B8-R1-M5-10
	Pressure regulator 1-32: PH		For port 2	2 ... 6 bar	564912	VMPA1-B8-R2-M5-06
	Pressure regulator 1-32: PC			2 ... 8.5 bar	564909	VMPA1-B8-R2-M5-10
	Pressure regulator 1-32: PG		For port 4	2 ... 6 bar	564913	VMPA1-B8-R3-M5-06
	Pressure regulator 1-32: PB			2 ... 8.5 bar	564910	VMPA1-B8-R3-M5-10
	Pressure regulator 1-32: PF	Pressure regulator plate with swivelling threaded connection M5	For port 1	0.5 ... 6 bar	549052	VMPA1-B8-R1C2-C-06
	Pressure regulator 1-32: PA			0.5 ... 8.5 bar	543339	VMPA1-B8-R1C2-C-10
	Pressure regulator 1-32: PH		For port 2	2 ... 6 bar	549053	VMPA1-B8-R2C2-C-06
	Pressure regulator 1-32: PC			2 ... 8.5 bar	543340	VMPA1-B8-R2C2-C-10
	Pressure regulator 1-32: PG		For port 4	2 ... 6 bar	549054	VMPA1-B8-R3C2-C-06
	Pressure regulator 1-32: PB			2 ... 8.5 bar	543341	VMPA1-B8-R3C2-C-10
	Pressure regulator 1-32: PS	Vertical pressure shut-off plate For manually disconnecting an individual valve from the compressed air supply of the valve terminal (duct 1 and 12/14 pilot air supply), operating pressure 3 ... 8 bar, internal pilot air supply			567805	VMPA1-HS
	Pressure gauge 1-32: VE	Screw-in pressure gauge with thread M5 for pressure regulator plate with swivelling threaded connection		Unit of measure: bar	132340	MA-15-10-M5
	Pressure gauge 1-32: VD			Unit of measure: psi	132341	MA-15-145-M5-PSI
	Pressure gauge 1-32: VC	Push-in fitting, self-sealing, with thread M5 for pressure regulator plate			153291	QSK-M5-4

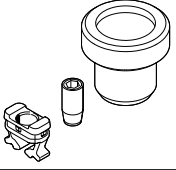
## Accessories

Ordering data		Code	Description	Part no.	Type
<b>Fixed flow restrictor – Width 10 mm</b>					
	Pneumatic connection 3, 1-40: V03	Hollow bolt, for restricting the exhaust air	3.5 ... 5.5 l/min	572544	VMPA1-FT-NW0.3-10
	Pneumatic connection 5, 1-40: Q03				
	Pneumatic connection 3, 1-40: V05				
	Pneumatic connection 5, 1-40: Q05				
	Pneumatic connection 3, 1-40: V07				
	Pneumatic connection 5, 1-40: Q07				
	Pneumatic connection 3, 1-40: V10				
	Pneumatic connection 5, 1-40: Q10				
	Pneumatic connection 3, 1-40: V12				
	Pneumatic connection 5, 1-40: Q12				
	Pneumatic connection 3, 1-40: V15				
	Pneumatic connection 5, 1-40: Q15				
	Pneumatic connection 3, 1-40: V17				
	Pneumatic connection 5, 1-40: Q17				
<b>Restrictor set – Width 10 mm</b>					
	–	Fixed flow restrictor, two of each size, two retainers and one assembly tool	572543	VMPA1-FT-NW0.3-1.7	
<b>Retainer for fixed flow restrictor – Width 10 mm</b>					
	–	Retainer for exhaust opening in the sub-base	572542	VMPA1-FTI-10	

Accessories

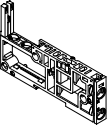
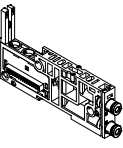
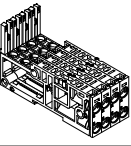
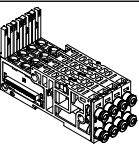
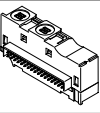
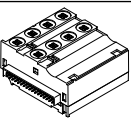



Ordering data		Code	Description	Part no.	Type	
<b>Sub-base – Width 10 mm</b>						
	Duct separation to the right of sub-base 1-40: –	Individual, without electrical manifold module, without cartridge	No duct separation	–	554311	VMPAL-AP-10
				With check valve	8035230	VMPAL-AP-10-RV
	Duct separation to the right of sub-base 1-40: T		Duct 1 separated	–	554312	VMPAL-AP-10-T1
				With check valve	8035231	VMPAL-AP-10-T1-RV
	Duct separation to the right of sub-base 1-40: TR		Duct 3, 5 separated	–	554313	VMPAL-AP-10-T35
				With check valve	8035232	VMPAL-AP-10-T35-RV
	Duct separation to the right of sub-base 1-40: TS		Duct 1 and 3, 5 separated	–	554315	VMPAL-AP-10-T135
				With check valve	8035233	VMPAL-AP-10-T135-RV
	–	Individual, with electrical manifold module, single solenoid (for 1 solenoid coil), with cartridge	No duct separation, tubing O.D.	4 mm	560994	VMPAL-AP-10-QS4-1
				6 mm	560987	VMPAL-AP-10-QS6-1
				5/32"	561005	VMPAL-AP-10-QS5/32"-1
				1/4"	560999	VMPAL-AP-10-QS1/4"-1
			Duct 1 separated, tubing O.D.	4 mm	561017	VMPAL-AP-10-QS4-1-T1
				6 mm	561011	VMPAL-AP-10-QS6-1-T1
				5/32"	561029	VMPAL-AP-10-QS5/32"-1-T1
				1/4"	561023	VMPAL-AP-10-QS1/4"-1-T1
		Individual, with electrical manifold module, double solenoid (for 2 solenoid coils), with cartridge	No duct separation, tubing O.D.	4 mm	560988	VMPAL-AP-10-QS4-2
				6 mm	560993	VMPAL-AP-10-QS6-2
				5/32"	561006	VMPAL-AP-10-QS5/32"-2
			Duct 1 separated, tubing O.D.	4 mm	561018	VMPAL-AP-10-QS4-2-T1
				6 mm	561012	VMPAL-AP-10-QS6-2-T1
				5/32"	561030	VMPAL-AP-10-QS5/32"-2-T1
1/4"	561024	VMPAL-AP-10-QS1/4"-2-T1				
<b>Combination of four sub-bases – Width 10 mm</b>						
	Combination manifold block: Z	Without electrical manifold module, without cartridge	–	–	560981	VMPAL-AP-4X10
	–	With electrical manifold module, single solenoid (for 1 solenoid coil), with cartridge	No duct separation, tubing O.D.	4 mm	561089	VMPAL-AP-4X10-QS4-1
				6 mm	561083	VMPAL-AP-4X10-QS6-1
				5/32"	561101	VMPAL-AP-4X10-QS5/32"-1
				1/4"	561095	VMPAL-AP-4X10-QS1/4"-1
		With electrical manifold module, double solenoid (for 2 solenoid coils), with cartridge	No duct separation, tubing O.D.	4 mm	561090	VMPAL-AP-4X10-QS4-2
				6 mm	561084	VMPAL-AP-4X10-QS6-2
				5/32"	561102	VMPAL-AP-4X10-QS5/32"-2
				1/4"	561096	VMPAL-AP-4X10-QS1/4"-2
<b>Electrical manifold module – Width 10 mm</b>						
	Type of module block 1-40: C	For one sub-base (1 valve position)	Grey – single solenoid (1 solenoid coil)	–	560961	VMPAL-EVAP-10-1
	Type of module block 1-40: A					
	Type of module block 1-40: C	For combination of four sub-bases (4 valve positions)	Grey – single solenoid (4 solenoid coils)	–	560967	VMPAL-EVAP-10-1-4
	Type of module block 1-40: A		Black – double solenoid (8 solenoid coils)			

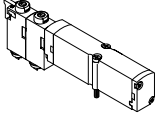
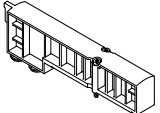

## Accessories

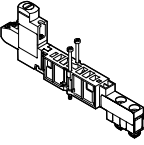
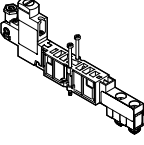
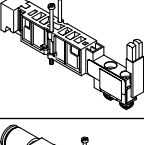
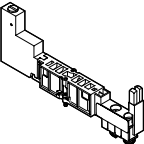
Ordering data		Code	Valve function	Part no.	Type
<b>Individual solenoid valve – Width 14 mm</b>					
	<b>5/2-way valve</b>				
	Position function 1-32: M	Single solenoid		573718	VMPA14-M1H-M-PI
	Position function 1-32: MS	Single solenoid		573974	VMPA14-M1H-MS-PI
	Position function 1-32: J	Double solenoid		573717	VMPA14-M1H-J-PI
	<b>2x 3/2-way valve</b>				
	Position function 1-32: N	Normally open		573725	VMPA14-M1H-N-PI
	Position function 1-32: NS	Normally open, mechanical spring return		575977	VMPA14-M1H-NS-PI
	Position function 1-32: K	Normally closed		573724	VMPA14-M1H-K-PI
	Position function 1-32: KS	Normally closed, mechanical spring return		575976	VMPA14-M1H-KS-PI
	Position function 1-32: H	1x normally open, 1x normally closed		573726	VMPA14-M1H-H-PI
	Position function 1-32: HS	1x normally open, 1x normally closed, mechanical spring return		575979	VMPA14-M1H-HS-PI
	<b>5/3-way valve</b>				
	Position function 1-32: B	Mid-position pressurised		573719	VMPA14-M1H-B-PI
	Position function 1-32: G	Mid-position closed		573721	VMPA14-M1H-G-PI
	Position function 1-32: E	Mid-position exhausted		573720	VMPA14-M1H-E-PI
	<b>3/2-way valve</b>				
	Position function 1-32: W	Normally open, external compressed air supply		573723	VMPA14-M1H-W-PI
	Position function 1-32: X	Normally closed, external compressed air supply		573722	VMPA14-M1H-X-PI
	<b>2x 2/2-way valve</b>				
	Position function 1-32: D	Normally closed		573727	VMPA14-M1H-D-PI
Position function 1-32: DS	Normally closed, mechanical spring return		575978	VMPA14-M1H-DS-PI	
Position function 1-32: I	1x normally closed, 1x normally closed, reversible only		573728	VMPA14-M1H-I-PI	
<b>Vacant position – Width 14 mm</b>					
	Position function 1-32: L	Cover plate for a valve position in width 14 mm A self-adhesive label is supplied.		573729	VMPA14-RP

Accessories

Ordering data		Code	Description	Part no.	Type	
<b>Vertical stacking modules – Width 10 mm</b>						
	Pressure regulator 1-32: PF	Optional pressure gauge	Pressure regulator for 1	0.5 ... 6 bar	8043342	VMPA14-B8-R1C2-C-06
	Pressure regulator 1-32: PA			0.5 ... 8.5 bar	8043339	VMPA14-B8-R1C2-C-10
	Pressure regulator 1-32: PH		Pressure regulator for 2	2 ... 6 bar	8043343	VMPA14-B8-R2C2-C-06
	Pressure regulator 1-32: PC			2 ... 6 bar	8043340	VMPA14-B8-R2C2-C-10
	Pressure regulator 1-32: PG		Pressure regulator for 4	2 ... 6 bar	8043344	VMPA14-B8-R3C2-C-06
	Pressure regulator 1-32: PB			2 ... 6 bar	8043341	VMPA14-B8-R3C2-C-10
	Pressure regulator 1-32: PF	–	Pressure regulator for 1	0.5 ... 6 bar	8043518	VMPA14-B8-R1-M5-06
	Pressure regulator 1-32: PA			0.5 ... 8.5 bar	8043515	VMPA14-B8-R1-M5-10
	Pressure regulator 1-32: PH		Pressure regulator for 2	2 ... 6 bar	8043519	VMPA14-B8-R2-M5-06
	Pressure regulator 1-32: PC			2 ... 6 bar	8043516	VMPA14-B8-R2-M5-10
	Pressure regulator 1-32: PG		Pressure regulator for 4	2 ... 6 bar	8043520	VMPA14-B8-R3-M5-06
	Pressure regulator 1-32: PB			2 ... 6 bar	8043517	VMPA14-B8-R3-M5-10
	Pressure regulator 1-32: PV	Vertical pressure supply plate	Connecting thread	G1/8	8110621	VMPA14-VSP-0
				With fitting for tubing O.D.		
8 mm	8110622	VMPA14-VSP-QS8				
10 mm	8110625	VMPA14-VSP-QS10				
1/4"	8110626	VMPA14-VSP-QS1/4				
5/16"	8110624	VMPA14-VSP-QS5/16				
3/8"	8110623	VMPA14-VSP-QS3/8				
	Pressure regulator 1-32: PS	Vertical pressure shut-off plate For manually disconnecting an individual valve from the compressed air supply of the valve terminal (duct 1 and 12/14 pilot air supply), operating pressure 3 ... 8 bar, internal pilot air supply			8110429	VMPA14-HS
	Pressure gauge 1-32: VE	Screw-in pressure gauge with thread M5 for pressure regulator plate with swivelling threaded connection	Unit of measure: bar	132340	MA-15-10-M5	
	Pressure gauge 1-32: VD		Unit of measure: psi	132341	MA-15-145-M5-PSI	
	Pressure gauge 1-32: VC	Push-in fitting, self-sealing, with thread M5 for pressure regulator plate		153291	QSK-M5-4	
<b>Check valve – Width 14 mm</b>						
	–	Check valve for installation in duct 3 or 5 (scope of delivery: 10 check valves, one assembly tool)		8039820	VMPA14RV	



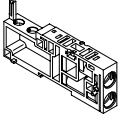
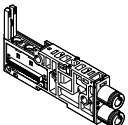
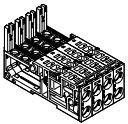
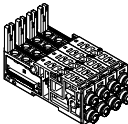
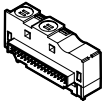
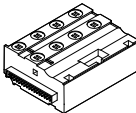

## Accessories

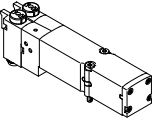
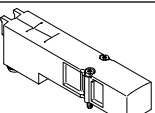
Ordering data		Code	Valve function	Part no.	Type	
<b>Sub-base – Width 14 mm</b>						
	Duct separation to the right of sub-base 1-40: –	Individual, without electrical manifold module, without cartridge	No duct separation	–	560973	VMPAL-AP-14
				With check valve	8034557	VMPAL-AP-14-RV
			Duct 1 separated	–	560975	VMPAL-AP-14-T1
				With check valve	8034558	VMPAL-AP-14-T1-RV
	Duct separation to the right of sub-base 1-40: T		Duct 3, 5 separated	–	560977	VMPAL-AP-14-T35
				With check valve	8034559	VMPAL-AP-14-T35-RV
	Duct separation to the right of sub-base 1-40: TR		Duct 1 and 3, 5 separated	–	560979	VMPAL-AP-14-T135
				With check valve	8034560	VMPAL-AP-14-T135-RV
	–	Individual, with electrical manifold module, single solenoid (for 1 solenoid coil), with cartridge	No duct separation, tubing O.D.	6 mm	560995	VMPAL-AP-14-QS6-1
				8 mm	560989	VMPAL-AP-14-QS8-1
				1/4"	561007	VMPAL-AP-14-QS1/4"-1
				5/16"	561001	VMPAL-AP-14-QS5/16"-1
			Duct 1 separated, tubing O.D.	6 mm	561019	VMPAL-AP-14-QS6-1-T1
				8 mm	561013	VMPAL-AP-14-QS8-1-T1
				1/4"	561031	VMPAL-AP-14-QS1/4"-1-T1
				5/16"	561025	VMPAL-AP-14-QS5/16"-1-T1
		Individual, with electrical manifold module, double solenoid (for 2 solenoid coils), with cartridge	No duct separation, tubing O.D.	6 mm	560996	VMPAL-AP-14-QS6-2
				8 mm	560990	VMPAL-AP-14-QS8-2
				1/4"	561008	VMPAL-AP-14-QS1/4"-2
				5/16"	561002	VMPAL-AP-14-QS5/16"-2
			Duct 1 separated, tubing O.D.	6 mm	561020	VMPAL-AP-14-QS6-2-T1
				8 mm	561014	VMPAL-AP-14-QS8-2-T1
				1/4"	561032	VMPAL-AP-14-QS1/4"-2-T1
				5/16"	561026	VMPAL-AP-14-QS5/16"-2-T1
<b>Combination of four sub-bases – Width 14 mm</b>						
	Combination manifold block: Z	Without electrical manifold module, without cartridge	–	–	560983	VMPAL-AP-4X14
	–	With electrical manifold module, single solenoid (for 1 solenoid coil), with cartridge	No duct separation, tubing O.D.	6 mm	561091	VMPAL-AP-4X14-QS6-1
				8 mm	561085	VMPAL-AP-4X14-QS8-1
				1/4"	561103	VMPAL-AP-4X14-QS1/4"-1
				5/16"	561097	VMPAL-AP-4X14-QS5/16"-1
		With electrical manifold module, double solenoid (for 2 solenoid coils), with cartridge	No duct separation, tubing O.D.	6 mm	561092	VMPAL-AP-4X14-QS6-2
				8 mm	561086	VMPAL-AP-4X14-QS8-2
				1/4"	561104	VMPAL-AP-4X14-QS1/4"-2
				5/16"	561098	VMPAL-AP-4X14-QS5/16"-2
<b>Electrical manifold module – Width 14 mm</b>						
	Type of module block 1-40: F	For one sub-base (1 valve position)	Grey – single solenoid (1 solenoid coil)	560963	VMPAL-EVAP-14-1	
	Type of module block 1-40: E			560964	VMPAL-EVAP-14-2	
	Type of module block 1-40: F	For combination of four sub-bases (4 valve positions)	Grey – single solenoid (4 solenoid coils)	560969	VMPAL-EVAP-14-1-4	
	Type of module block 1-40: E			560970	VMPAL-EVAP-14-2-4	

Accessories

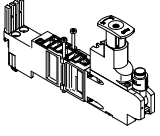
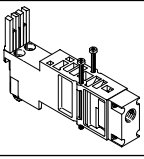
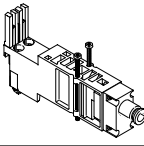
Ordering data		Code	Valve function	Part no.	Type
<b>Individual solenoid valve – Width 20 mm</b>					
	<b>5/2-way valve</b>				
	Position function 1-32: M	Single solenoid		8022034	VMPA2-M1BH-M-PI
	Position function 1-32: MS	Single solenoid, mechanical spring return		571333	VMPA2-M1H-MS-PI
	Position function 1-32: J	Double solenoid		8022035	VMPA2-M1BH-J-PI
	<b>2x 3/2-way valve</b>				
	Position function 1-32: N	Normally open		537958	VMPA2-M1H-N-PI
	Position function 1-32: NS	Normally open, mechanical spring return		568655	VMPA2-M1H-NS-PI
	Position function 1-32: K	Normally closed		537957	VMPA2-M1H-K-PI
	Position function 1-32: KS	Normally closed, mechanical spring return		568656	VMPA2-M1H-KS-PI
	Position function 1-32: H	1x normally open, 1x normally closed		537959	VMPA2-M1H-H-PI
	Position function 1-32: HS	1x normally open, 1x normally closed, mechanical spring return		568658	VMPA2-M1H-HS-PI
	<b>5/3-way valve</b>				
	Position function 1-32: B	Mid-position pressurised		8022036	VMPA2-M1BH-B-PI
	Position function 1-32: G	Mid-position closed		8022037	VMPA2-M1BH-G-PI
	Position function 1-32: E	Mid-position exhausted		8022038	VMPA2-M1BH-E-PI
	<b>1x 3/2-way valve</b>				
	Position function 1-32: W	Normally open, external compressed air supply		8022040	VMPA2-M1BH-W-PI
	Position function 1-32: X	Normally closed, external compressed air supply		8022039	VMPA2-M1BH-X-PI
	<b>2x 2/2-way valve</b>				
	Position function 1-32: D	Normally closed		537960	VMPA2-M1H-D-PI
Position function 1-32: DS	Normally closed, mechanical spring return		568657	VMPA2-M1H-DS-PI	
Position function 1-32: I	1x normally closed, 1x normally closed, reversible only		543703	VMPA2-M1H-I-PI	
<b>Vacant position – Width 20 mm</b>					
	Position function 1-32: L	Cover plate for a valve position in width 20 mm A self-adhesive label is supplied.		537962	VMPA2-RP



## Accessories

Ordering data		Code	Valve function	Part no.	Type	
<b>Vertical stacking modules – Width 20 mm</b>						
	Pressure regulator 1-32: PA	Pressure regulator plate (with 10 mm cartridge connection for pressure gauge)	For port 1	0.5 ... 8.5 bar	543342	VMPA2-B8-R1C2-C-10
	Pressure regulator 1-32: PF			0.5 ... 6 bar	549055	VMPA2-B8-R1C2-C-06
	Pressure regulator 1-32: PC		For port 2	2 ... 8.5 bar	543343	VMPA2-B8-R2C2-C-10
	Pressure regulator 1-32: PH			2 ... 6 bar	549056	VMPA2-B8-R2C2-C-06
	Pressure regulator 1-32: PB		For port 4	2 ... 8.5 bar	543344	VMPA2-B8-R3C2-C-10
	Pressure regulator 1-32: PG			2 ... 6 bar	549057	VMPA2-B8-R3C2-C-06
	Pressure regulator 1-32: PL		For port 2, reversible	0.5 ... 8.5 bar	543347	VMPA2-B8-R6C2-C-10
	Pressure regulator 1-32: PN			0.5 ... 6 bar	549113	VMPA2-B8-R6C2-C-06
	Pressure regulator 1-32: PK		For port 4, reversible	0.5 ... 8.5 bar	543348	VMPA2-B8-R7C2-C-10
	Pressure regulator 1-32: PM			0.5 ... 6 bar	549114	VMPA2-B8-R7C2-C-06
			Pressure regulator 1-32: PV	Vertical pressure supply plate	Connecting thread	G1/8
		With fitting for tubing O.D.	6 mm			8035441
			8 mm		8029488	VMPA2-VSP-QS8
			10 mm		8029489	VMPA2-VSP-QS10
			1/4"		8035442	VMPA2-VSP-QS1/4
			5/16"		8029491	VMPA2-VSP-QS5/16
	Pressure gauge 1-32: T	Pressure gauge, 10 mm cartridge connection, for pressure regulator plate	Display unit bar/psi	0 ... 16 bar	543487	PAGN-26-16-P10
	–			0 ... 10 bar	543488	PAGN-26-10-P10
			Display unit MPa	0 ... 1.0 MPa	563736	PAGN-26-1M-P10
	Pressure gauge 1-32: VF	Threaded adapter for cartridge connection 10 mm to thread G1/8		565811	QSP10-G1/8	
<b>Check valve – Width 20 mm</b>						
	–	Check valve for installation in duct 3 or 5 (scope of delivery: 10 check valves, one assembly tool)		8039821	VMPA2RV	

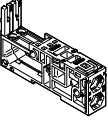
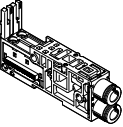
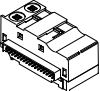



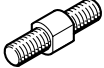
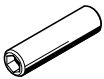
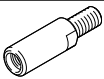
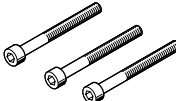

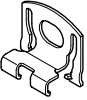
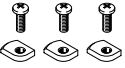

Accessories

Ordering data		Code	Description	Part no.	Type		
<b>Sub-base – Width 20 mm</b>							
	Duct separation to the right of sub-base 1-40: –	Individual, without electrical manifold module, without cartridge	No duct separation	–	560974	VMPAL-AP-20	
				With check valve	8034561	VMPAL-AP-20-RV	
	Duct separation to the right of sub-base 1-40: T			Duct 1 separated	–	560976	VMPAL-AP-20-T1
					With check valve	8034562	VMPAL-AP-20-T1-RV
	Duct separation to the right of sub-base 1-40: TR			Duct 3, 5 separated	–	560978	VMPAL-AP-20-T35
					With check valve	8034563	VMPAL-AP-20-T35-RV
	Duct separation to the right of sub-base 1-40: TS			Duct 1 and 3, 5 separated	–	560980	VMPAL-AP-20-T135
					With check valve	8034564	VMPAL-AP-20-T135-RV
	–	Individual, with electrical manifold module, single solenoid (for 1 solenoid coil), with cartridge	No duct separation, tubing O.D.	8 mm	560997	VMPAL-AP-20-QS8-1	
				10 mm	560991	VMPAL-AP-20-QS10-1	
				5/16"	561009	VMPAL-AP-20-QS5/16"-1	
			3/8"	561003	VMPAL-AP-20-QS3/8"-1		
			Duct 1 separated, tubing O.D.	8 mm	561021	VMPAL-AP-20-QS8-1-T1	
				10 mm	561015	VMPAL-AP-20-QS10-1-T1	
		5/16"		561033	VMPAL-AP-20-QS5/16"-1-T1		
		3/8"	561027	VMPAL-AP-20-QS3/8"-1-T1			
			Individual, with electrical manifold module, double solenoid (for 2 solenoid coils), with cartridge	No duct separation, tubing O.D.	8 mm	560998	VMPAL-AP-20-QS8-2
		10 mm			560992	VMPAL-AP-20-QS10-2	
		5/16"			561010	VMPAL-AP-20-QS5/16"-2	
		3/8"		561004	VMPAL-AP-20-QS3/8"-2		
		Duct 1 separated, tubing O.D.		8 mm	561022	VMPAL-AP-20-QS8-2-T1	
				10 mm	561016	VMPAL-AP-20-QS10-2-T1	
5/16"	561034		VMPAL-AP-20-QS5/16"-2-T1				
3/8"	561028	VMPAL-AP-20-QS3/8"-2-T1					
<b>Electrical manifold module – Width 20 mm</b>							
	Type of module block 1-40: D	For one sub-base (1 valve position)	Grey – single solenoid (1 solenoid coil)	560965	VMPAL-EVAP-20-1		
	Type of module block 1-40: B			Black – double solenoid (2 solenoid coils)	560966	VMPAL-EVAP-20-2	

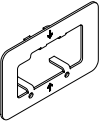
## Accessories

Ordering data		Code	Description	Pack size	Part no.	Type
<b>Tie rod</b>						
	Tie rod: –	Threaded rod for tie rod, width across flats 5 mm The threaded rod/sleeve combination is selected based on the number and width of the individual sub-bases.	5 mm	3	561116	VMPAL-ZAS-5
			45 mm	3	561117	VMPAL-ZAS-45
			85 mm	3	561118	VMPAL-ZAS-85
			125 mm	3	561119	VMPAL-ZAS-125
			165 mm	3	561120	VMPAL-ZAS-165
			205 mm	3	561121	VMPAL-ZAS-205
			245 mm	3	561122	VMPAL-ZAS-245
			285 mm	3	561123	VMPAL-ZAS-285
			325 mm	3	561124	VMPAL-ZAS-325
			365 mm	3	561125	VMPAL-ZAS-365
			405 mm	3	561126	VMPAL-ZAS-405
			445 mm	3	561127	VMPAL-ZAS-445
			485 mm	3	561128	VMPAL-ZAS-485
			525 mm	3	561129	VMPAL-ZAS-525
			565 mm	3	561130	VMPAL-ZAS-565
			605 mm	3	561131	VMPAL-ZAS-605
			645 mm	3	561132	VMPAL-ZAS-645
685 mm	3	561133	VMPAL-ZAS-685			
725 mm	3	561134	VMPAL-ZAS-725			
765 mm	3	561175	VMPAL-ZAS-765			
805 mm	3	561176	VMPAL-ZAS-805			
	–	Sleeve, internal hexagon 4 mm	36 mm	3	561135	VMPAL-ZAH-36
			46 mm	3	561136	VMPAL-ZAH-46
			56 mm	3	561137	VMPAL-ZAH-56
			66 mm	3	561138	VMPAL-ZAH-66
	–	Tie rod extender for subsequently extending the valve terminal with one sub-base in width	10 mm	3	561139	VMPAL-ZAE-10
			14 mm	3	561140	VMPAL-ZAE-14
			20 mm	3	561141	VMPAL-ZAE-20
		Tie rod extender for subsequently extending the valve terminal with a supply module	20 mm	3	561141	VMPAL-ZAE-20
			Tie rod extender for subsequently extending the valve terminal with four sub-bases in width	10 mm	3	570779
	–	M4 screw with internal hexagon 2.5 mm, for tie rod	14 mm	3	570780	VMPAL-ZAE-14-4
			30 mm	3	571924	VMPAL-M4X30
<b>Screw</b>						
	–	M3 screw and square nut for linking four sub-bases	39 mm	10	561142	VMPAL-MS-4x10

Accessories

Ordering data						
	Code	Description	Pack size	Part no.	Type	
<b>Mounting</b>						
	-	Mounting bracket Wall brackets should be mounted max. every 13 cm on the valve terminal.	-	560949	VMPAL-BD	
<b>H-rail mounting</b>						
	Mounting accessories: H	MPA-L with multi-pin plug connection	-	526032	CPX-CPA-BG-NRH	
	Mounting accessories: H	MPA-L with fieldbus interface	-	560798	VMPAF-FB-BG-NRH	
<b>Releasing tool</b>						
	-	For releasing the electrical manifold module from the sub-base	-	572017	VMPAL-LW	
<b>Cover cap</b>						
	Manual override: N	Cover cap for manual override, non-detenting	-	540897	VMPA-HBT-B	
	Manual override: V	Cover cap for manual override, concealed	-	540898	VMPA-HBV-B	
	Manual override: Y	Cover cap for manual override, detenting without accessories	-	8002234	VAMC-L1-CD	
	-	Identification holder for an inscription label and covering for the manual override	-	570818	ASLR-D-L1	
<b>Inscription label holders/inscription labels</b>						
	Inscription label holder for sub-bases: TM	Holder for inscription label IBS-6x10	Width 10 mm	10	561109	VMPAL-ST-AP-10
			Width 14 mm	10	561112	VMPAL-ST-AP-14
			Width 20 mm	10	561115	VMPAL-ST-AP-20
	-	Inscription label, 6x10 mm	-	18576	IBS-6X10	



## Accessories

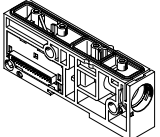
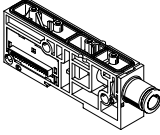
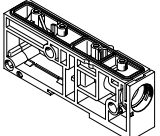
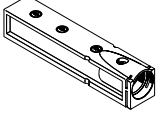
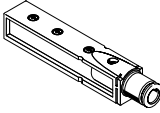
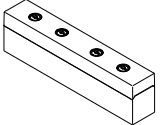
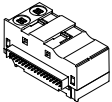

Ordering data		Code	Description	Part no.	Type
<b>Supply module</b>					
	Type of module block 1-40: U	With electrical manifold module, without cartridge		<b>560950</b>	<b>VMPAL-SP-0</b>
	Type of module block 1-40: U	With electrical manifold module, with cartridge for tubing O.D.	8 mm	<b>573645</b>	<b>VMPAL-SP-QS8</b>
			10 mm	<b>560951</b>	<b>VMPAL-SP-QS10</b>
			12 mm	<b>560952</b>	<b>VMPAL-SP-QS12</b>
			5/16"	<b>573646</b>	<b>VMPAL-SP-QS5/16"</b>
			3/8"	<b>560953</b>	<b>VMPAL-SP-QS3/8"</b>
	Type of module block 1-40: U	Without electrical manifold module, without cartridge		<b>570774</b>	<b>VMPAL-SP</b>
<b>Plate</b>					
	Exhaust port: UD, UE, UF, UM, UN, UP or UG	Exhaust plate for ducted exhaust air, without cartridge		<b>560956</b>	<b>VMPAL-EG</b>
	Exhaust port: UE	Exhaust plate for ducted exhaust air, with cartridge for tubing O.D. 10 mm		<b>560957</b>	<b>VMPAL-EG-QS10</b>
	Exhaust port: UN	Exhaust plate for ducted exhaust air, with cartridge for tubing O.D. 3/8"		<b>560959</b>	<b>VMPAL-EG-QS3/8"</b>
	Exhaust port: -	Flat plate silencer		<b>560955</b>	<b>VMPAL-EU</b>
<b>Electrical manifold module</b>					
	Type of module block 1-40: U	Black For supply module (signals are passed through)		<b>571011</b>	<b>VMPAL-EVAP-20-SP</b>

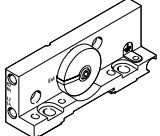
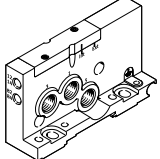
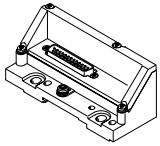
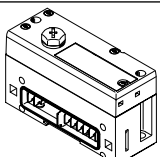
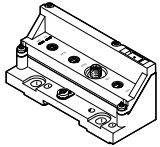
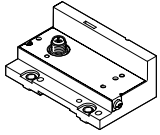
Accessories





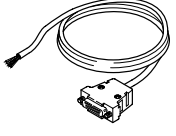
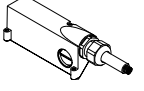
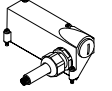
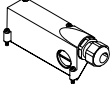



Ordering data		Code	Description	Part no.	Type
<b>Right-hand end plate</b>					
	Right-hand end plate: -	Low, with ports 12/14, 82/84, with pilot air selector for choosing the pilot air supply (internal or external)		<b>560945</b>	<b>VMPAL-EPR</b>
	Right-hand end plate: D	High, with ports 1, 3, 5, 12/14, 82/84, with pilot air selector for choosing the pilot air supply (internal or external), reversible operation possible		<b>560947</b>	<b>VMPAL-EPR-SP</b>
<b>Left-hand end plate</b>					
	Electrical connection: MS2	Electrical interface for multi-pin plug connection, IP40	Sub-D, 9-pin, 8 addresses	<b>570777</b>	<b>VMPAL-EPL-SD9-IP40</b>
	Electrical connection: MS1		Sub-D, 25-pin, 24 addresses	<b>560940</b>	<b>VMPAL-EPL-SD25-IP40</b>
	Electrical connection: MS3		Sub-D, 44-pin, 32 addresses	<b>560941</b>	<b>VMPAL-EPL-SD44-IP40</b>
	Electrical connection: MF1		Ribbon cable, 40-pin, 32 addresses	<b>560942</b>	<b>VMPAL-EPL-FL40-IP40</b>
	Electrical connection: MC		Terminal strip, 33-pin, 32 addresses	<b>560943</b>	<b>VMPAL-EPL-KL33-IP40</b>
	Electrical connection: MS6 Electrical connection: MS8	Electrical interface for multi-pin plug connection, IP67	Sub-D, 25-pin, 24 addresses Sub-D, 44-pin, 32 addresses	<b>560938</b> <b>560939</b>	<b>VMPAL-EPL-SD25</b> <b>VMPAL-EPL-SD44</b>
	Electrical connection: CX	Pneumatic interface for CPX terminal	32 addresses	<b>570783</b>	<b>VMPAL-EPL-CPX</b>
	Electrical connection: API	Pneumatic interface for automation system CPX-AP-I	32 addresses	<b>8087171</b>	<b>VMPAL-EPL-AP</b>
	Electrical connection: LK	Node with IO-Link	32 addresses	<b>575667</b>	<b>VMPAL-EPL-IPO32</b>
	Electrical connection: PT	Node with I-Port interface			

1) A self-adhesive label is supplied.



## Accessories

Ordering data		Code	Description	Part no.	Type	
<b>Connecting cable for multi-pin plug connection with Sub-D plug socket, degree of protection IP40</b>						
	Connecting cable: DA	Socket 9-pin, Sub-D, open cable end 9-pin	2.5 m	531184	KMP6-09P-8-2.5	
	Connecting cable: DB		5 m	531185	KMP6-09P-8-5	
	Connecting cable: DC		10 m	531186	KMP6-09P-8-10	
	–	Socket 25-pin, Sub-D, open cable end 15-pin	2.5 m	530049	KMP6-25P-12-2.5	
	–		5 m	530050	KMP6-25P-12-5	
	–		10 m	530051	KMP6-25P-12-10	
	Connecting cable: DD	Socket 25-pin, Sub-D, open cable end 25-pin	2.5 m	530046	KMP6-25P-20-2.5	
	Connecting cable: DK		5 m	530047	KMP6-25P-20-5	
	Connecting cable: DF		10 m	530048	KMP6-25P-20-10	
	Connecting cable: DG	Socket 44-pin, Sub-D, open cable end 44-pin	2.5 m	575113	NEBV-S1G44-K-2.5-N-LE44-S6	
	Connecting cable: DH		5 m	575114	NEBV-S1G44-K-5-N-LE44-S6	
	Connecting cable: DJ		10 m	575115	NEBV-S1G44-K-10-N-LE44-S6	
<b>Connecting cable for multi-pin plug connection with Sub-D plug socket, degree of protection IP67</b>						
	Connecting cable: CA	Cable outlet to front (only with left-hand end plate MS6)	25-pin	2.5 m	560416	VMPAL-KM-V-SD25-IP67-2.5
	Connecting cable: CB		5 m	560417	VMPAL-KM-V-SD25-IP67-5	
	Connecting cable: CC		10 m	560418	VMPAL-KM-V-SD25-IP67-10	
	–		0.5 ... 30 m	562389	VMPAL-KM-V-SD25-IP67-	
	Connecting cable: CQ	Cable outlet to front (only with left-hand end plate MS6)	25-pin	2.5 m	560410	VMPAL-KMSK-V-SD25-IP67-2.5
	Connecting cable: CR		5 m	560411	VMPAL-KMSK-V-SD25-IP67-5	
	Connecting cable: CS		10 m	560412	VMPAL-KMSK-V-SD25-IP67-10	
	–		0.5 ... 30 m	562391	VMPAL-KMSK-V-SD25-IP67-	
	Connecting cable: CJ	Cable outlet to front (only with left-hand end plate MS8)	44-pin	2.5 m	560422	VMPAL-KM-V-SD44-IP67-2.5
	Connecting cable: CK		5 m	560423	VMPAL-KM-V-SD44-IP67-5	
	Connecting cable: CL		10 m	560424	VMPAL-KM-V-SD44-IP67-10	
	–		0.5 ... 30 m	562390	VMPAL-KM-V-SD44-IP67-	
	Connecting cable: CD	Cable outlet to side (only with left-hand end plate MS6)	25-pin	2.5 m	560419	VMPAL-KM-S-SD25-IP67-2.5
	Connecting cable: CE		5 m	560420	VMPAL-KM-S-SD25-IP67-5	
	Connecting cable: CH		10 m	560421	VMPAL-KM-S-SD25-IP67-10	
	–		0.5 ... 30 m	562392	VMPAL-KM-S-SD25-IP67-	
	Connecting cable: CT	Cable outlet to side (only with left-hand end plate MS6)	25-pin	2.5 m	560413	VMPAL-KMSK-S-SD25-IP67-2.5
	Connecting cable: CU		5 m	560414	VMPAL-KMSK-S-SD25-IP67-5	
	Connecting cable: CV		10 m	560415	VMPAL-KMSK-S-SD25-IP67-10	
	–		0.5 ... 30 m	562394	VMPAL-KMSK-S-SD25-IP67-	
	Connecting cable: CM	Cable outlet to side (only with left-hand end plate MS8)	44-pin	2.5 m	560425	VMPAL-KM-S-SD44-IP67-2.5
	Connecting cable: CN		5 m	560426	VMPAL-KM-S-SD44-IP67-5	
	Connecting cable: CP		10 m	560427	VMPAL-KM-S-SD44-IP67-10	
	–		0.5 ... 30 m	562393	VMPAL-KM-S-SD44-IP67-	
<b>Hood for multi-pin plug connection without connecting cable with Sub-D plug socket, degree of protection IP67</b>						
	Electrical multi-pin plug hood: EZ	Cable outlet to side or front (only with left-hand end plate MS6)	25-pin	–	560428	VMPAL-KM-SD25-IP67-0
	Electrical multi-pin plug hood: EY	Outlet either to the side or front (only with left-hand end plate MS8)	44-pin	–	560429	VMPAL-KM-SD44-IP67-0
<b>Plug</b>						
	–	Self-assembly plug for ribbon cable, 40-pin, for ribbon cable conductor cross section 0.08 ... 0.13 mm <sup>2</sup>		570895	NECU-FCG40-K	



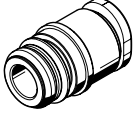
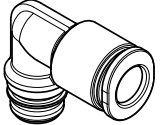
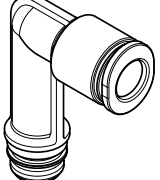

Accessories

Ordering data		Code	Description	Pack size	Part no.	Type	
<b>Cartridge for sub-base in width 10 mm</b>							
	Standard connection for valve size 10 mm:	AA	10 mm cartridge, plastic, for working ports, connection for tubing O.D.	3 mm	10	132621	QSPKG10-3
		AB		4 mm	10	132622	QSPKG10-4
		-		6 mm	10	132623	QSPKG10-6
		AJ		1/8"	10	132852	QSPKG10-1/8-U
		AQ		5/32"	10	132624	QSPKG10-5/32-U
		AL		1/4"	10	132626	QSPKG10-1/4-U
		-	10 mm cartridge, nickel-plated brass, for working ports, connection for tubing O.D.	4 mm	10	172972	QSP10-4
		-		6 mm	10	172973	QSP10-6
	-	10 mm cartridge, plastic, L-shaped, for working ports, connection for tubing O.D.	3 mm	10	132853	QSPLKG10-3	
	-		4 mm	10	132920	QSPLKG10-4	
	-		6 mm	10	132921	QSPLKG10-6	
	-		1/8"	10	132854	QSPLKG10-1/8-U	
	-		1/4"	10	132924	QSPLKG10-1/4-U	
	-	10 mm cartridge, plastic, L-shaped long, for working ports, connection for tubing O.D.	3 mm	10	132861	QSPLLKG10-3	
	-		4 mm	10	132925	QSPLLKG10-4	
	-		6 mm	10	132926	QSPLLKG10-6	
	-		1/8"	10	132862	QSPLLKG10-1/8-U	
	-		1/4"	10	132929	QSPLLKG10-1/4-U	
<b>Cartridge for sub-base in width 14 mm</b>							
	Standard connection for valve size 14 mm:	BC	14 mm cartridge, plastic, for working ports, connection for tubing O.D.	6 mm	10	132930	QSPKG14-6
		-		8 mm	10	132931	QSPKG14-8
		BL		1/4"	10	132932	QSPKG14-1/4-U
		BQ		5/16"	10	132933	QSPKG14-5/16-U
	-	14 mm cartridge, plastic, L-shaped, for working ports, connection for tubing O.D.	6 mm	10	132938	QSPLKG14-6	
	-		8 mm	10	132939	QSPLKG14-8	
	-		1/4"	10	132940	QSPLKG14-1/4-U	
	-		5/16"	10	132941	QSPLKG14-5/16-U	
	-	14 mm cartridge, plastic, L-shaped long, for working ports, connection for tubing O.D.	6 mm	10	132942	QSPLLKG14-6	
	-		8 mm	10	132943	QSPLLKG14-8	
	-		1/4"	10	132944	QSPLLKG14-1/4-U	
	-		5/16"	10	132945	QSPLLKG14-5/16-U	
<b>Cartridge for sub-base in width 20 mm</b>							
	Standard connection for valve size 20 mm:	CD	18 mm cartridge, plastic, for working ports, connection for tubing O.D.	8 mm	10	132649	QSPKG18-8
		-		10 mm	10	132650	QSPKG18-10
		CQ		5/16"	10	132651	QSPKG18-5/16-U
		CT		3/8"	10	132652	QSPKG18-3/8-U
	-	18 mm cartridge, plastic, L-shaped, for working ports, connection for tubing O.D.	8 mm	10	132946	QSPLKG18-8	
	-		10 mm	10	132947	QSPLKG18-10	
	-		5/16"	10	132948	QSPLKG18-5/16-U	
	-		3/8"	10	132949	QSPLKG18-3/8-U	
	-	18 mm cartridge, plastic, L-shaped long, for working ports, connection for tubing O.D.	8 mm	10	132950	QSPLLKG18-8	
	-		10 mm	10	132951	QSPLLKG18-10	
	-		5/16"	10	132952	QSPLLKG18-5/16-U	
	-		3/8"	10	132953	QSPLLKG18-3/8-U	

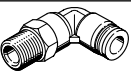

## Accessories

Ordering data		Code	Description	Pack size	Part no.	Type
<b>Cartridge for supply module</b>						
	-	20 mm cartridge, plastic, for supply ports, connection for tubing O.D.	8 mm	10	132633	QSPKG20-8
			10 mm	10	132634	QSPKG20-10
			12 mm	10	132635	QSPKG20-12
			5/16"	10	132636	QSPKG20-5/16-U
			3/8"	10	132637	QSPKG20-3/8-U
			1/2"	10	132638	QSPKG20-1/2-U
	-	20 mm cartridge, plastic, L-shaped, for supply ports, connection for tubing O.D.	8 mm	10	132855	QSPLKG20-8
			10 mm	10	132856	QSPLKG20-10
			12 mm	10	132857	QSPLKG20-12
			3/8"	10	132859	QSPLKG20-3/8-U
			1/2"	10	132860	QSPLKG20-1/2-U
	-	20 mm cartridge, plastic, L-shaped long, for supply ports, connection for tubing O.D.	8 mm	10	132863	QSPLLKG20-8
			10 mm	10	132864	QSPLLKG20-10
			12 mm	10	132865	QSPLLKG20-12
<b>Adapter for sub-bases</b>						
	Standard connection for valve size 10 mm: AGG	Adapter for cartridge connection 10 mm to thread M7	10	572380	VMPAL-F10-M7	
	Standard connection for valve size 14 mm: BGG	Adapter for cartridge connection 14 mm to thread G1/8	10	574084	VMPAL-F14-G1/8	
	Standard connection for valve size 20 mm: CGG	Adapter for cartridge connection 18 mm to thread G1/4	10	573914	VMPAL-F20-G1/4	
<b>Adapter for supply module/sub-base</b>						
	-	Adapter for cartridge connection 20 mm to thread G1/4	10	572381	VMPAL-FSP-G1/4	

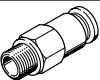
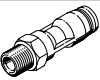
Accessories

Ordering data		Code	Description	Pack size	Part no.	Type	
<b>Push-in fitting</b>							
	-		Connecting thread M7 with sealing ring, with internal hexagon, for tubing O.D.	4 mm	10	153319	QSM-M7-4-I
			6 mm	10	153321	QSM-M7-6-I	
	-		Connecting thread G1/4 with sealing ring, with internal hexagon, for tubing O.D.	6 mm	10	186108	QS-G1/4-6-I
	-		Connecting thread G1/4 with sealing ring, with external hexagon, for tubing O.D.	6 mm	10	186097	QS-G1/4-6
				8 mm	10	186099	QS-G1/4-8
				10 mm	10	186101	QS-G1/4-10
				12 mm	10	578344	NPQH-D-G14-Q12-P10
	-		Connecting thread G1/4, with external hexagon, flame retardant, for tubing O.D.	6 mm	-	186316	QS-VO-G1/4-6
			8 mm	-	186317	QS-VO-G1/4-8	
			10 mm	-	186318	QS-VO-G1/4-10	
<b>Push-in L-connector</b>							
	-		Push-in sleeve diameter	6 mm	10	153057	QSL-6H
				8 mm	10	153058	QSL-8H
			Long push-in sleeve diameter	6 mm	10	153066	QSL-6HL
	-		Push-in fitting with sealing ring, connecting thread M7, with external hexagon, for tubing O.D.	4 mm	10	186352	QSML-M7-4
					100	130773	QSML-M7-4-100
				6 mm	10	186353	QSML-M7-6
		100	130774	QSML-M7-6-100			
	-		Long push-in fitting with sealing ring, connecting thread M7, with external hexagon, for tubing O.D.	4 mm	10	186354	QSMLL-M7-4
				6 mm	10	186355	QSMLL-M7-6
-		Push-in fitting with sealing ring, connecting thread G1/4, with external hexagon, for tubing O.D.	6 mm	10	186118	QSL-G1/4-6	
			8 mm	10	186120	QSL-G1/4-8	
			10 mm	10	186122	QSL-G1/4-10	
	-		Push-in fitting, connecting thread G1/4, with internal hexagon, for tubing O.D.	6 mm	10	186149	QSLV-G1/4-6-I
				8 mm	10	186151	QSLV-G1/4-8-I
<b>Push-in fittings, self-sealing</b>							
	-		With sealing ring, with external hexagon, connecting thread G1/4, for tubing O.D.	6 mm	1	186296	QSK-G1/4-6
				8 mm	1	186298	QSK-G1/4-8
				10 mm	1	186300	QSK-G1/4-10
	-		With sealing ring, with external hexagon, L-shaped, connecting thread G1/4, for tubing O.D.	6 mm	1	186306	QSKL-G1/4-6
				8 mm	1	186308	QSKL-G1/4-8
				10 mm	1	186310	QSKL-G1/4-10
<b>Push-in fittings, rotatable</b>							
	-		With external hexagon, connecting thread G1/4, for tubing O.D.	6 mm	1	186278	QSR-G1/4-6
				8 mm	1	186280	QSR-G1/4-8
	-		With external hexagon, L-shaped, connecting thread G1/4, for tubing O.D.	6 mm	1	186287	QSRL-G1/4-6
				8 mm	1	186289	QSRL-G1/4-8

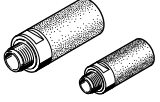
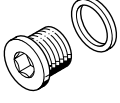
## Accessories

Ordering data		Code	Description	Pack size	Part no.	Type
<b>Silencers</b>						
	-	Connecting thread	M7	1	161418	UC-M7
				50	534218	UC-M7-50
			G1/4	1	165004	UC-1/4
				20	534220	UC-1/4-20
<b>Blanking plug</b>						
	-	Thread	M7	10	174309	B-M7
			G3/8	10	3570	B-3/8
		Cartridge	10 mm	1	172976	QSP10-PTB
			14 mm	1	172987	QSP14-PTB
			18 mm	1	172996	QSP17-PTB
<b>User documentation</b>						
	Documentation: DE	MPA-L pneumatic components	German	-	556353	MPAL-VI-DE
	Documentation: EN		English	-	556354	MPAL-VI-EN
	Documentation: FR		French	-	556356	P.BE-MPAL-FR
	Documentation: ES		Spanish	-	556355	P.BE-MPAL-ES
	Documentation: IT		Italian	-	556357	P.BE-MPAL-IT