

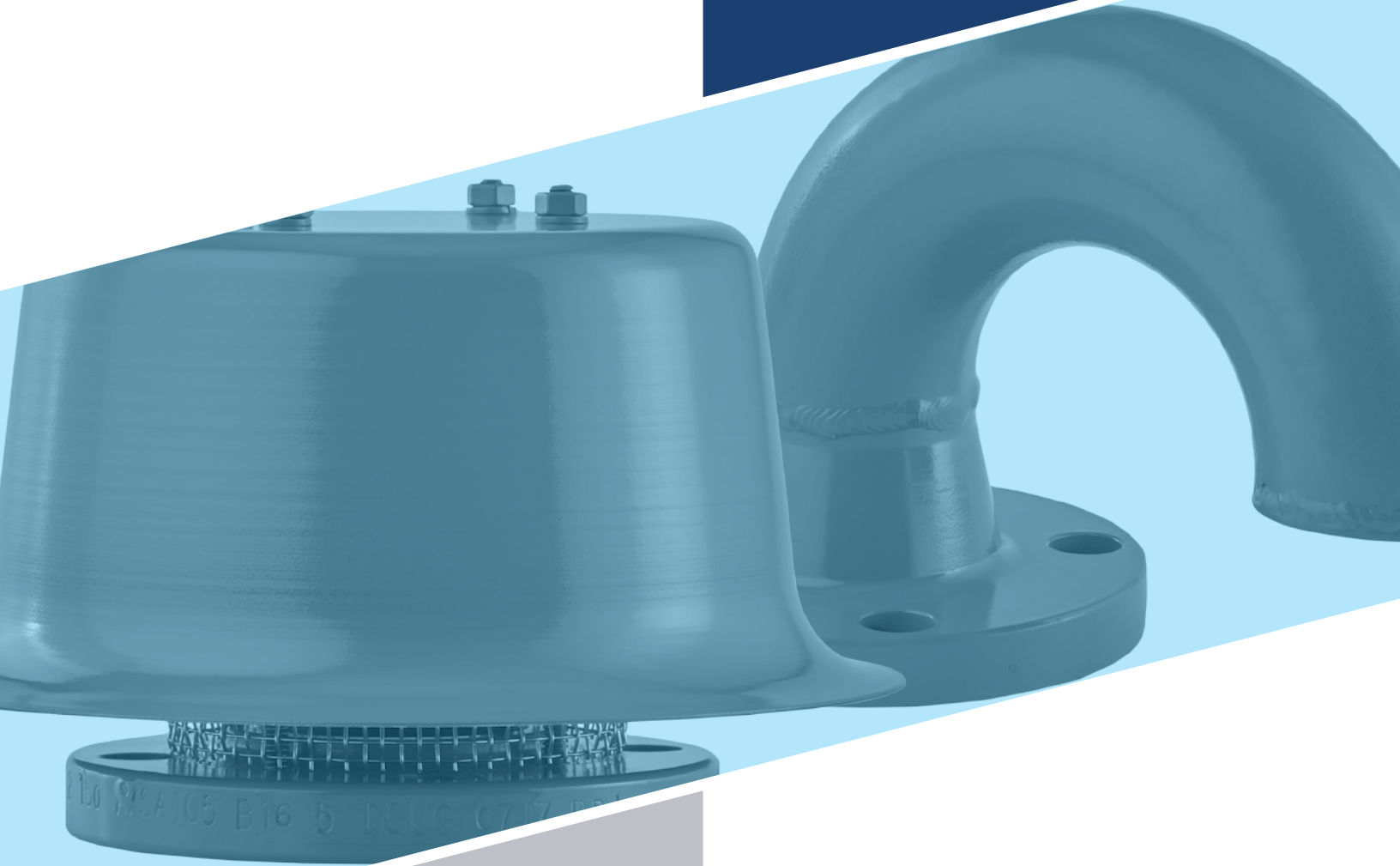

FREE VENT

MODELS 5000 & 5100



MODELS 5000 & 5100

5000 SERIES

The Groth 5000 Series Free Vents are designed to be used on tanks containing non-volatile liquids and on vent pipe extremities. Groth Free Vents offer efficient flow capacity for the protection of the tank.

Technical Details

- Sizes: 2" (DN 50) through 12" (DN 300)
- Materials: Carbon Steel, Stainless Steel and other materials

Features

- High flow capacity
- Built of corrosion resistant materials throughout
- Wire mesh screen prevents foreign matter from entering the tank or pipe opening



Model 5000



Model 5100

SPECIFICATIONS

Model 5000				Model 5100			
Size [°] Flange In (mm)	A Width In (mm)	B Height In (mm)	Approx. Ship Weight Lbs (kg)	Size [°] Flange In (mm)	AA Width In (mm)	BB Height In (mm)	Approx. Ship Weight Lbs (kg)
2 (50)	10.25 (260)	6.87 (174)	8 (4)	2 (50)	9.50 (241)	5.37 (136)	11 (5)
3 (80)	14.50 (368)	9.25 (235)	20 (9)	3 (80)	11.50 (292)	5.81 (148)	14 (6)
4 (100)	18.75 (476)	11.37 (289)	35 (16)	4 (100)	13 (330)	6.31 (160)	18 (8)
6 (150)	26.87 (682)	15.68 (398)	70 (32)	6 (150)	17 (432)	7.37 (187)	28 (13)
8 (200)	35.12 (892)	20.12 (511)	135 (61)	8 (200)	19.50 (495)	9.25 (235)	42 (19)
10 (250)	43.37 (1102)	24 (610)	235 (107)	10 (250)	23.50 (587)	10.62 (270)	60 (27)
12 (300)	51.87 (1317)	28.43 (722)	350 (159)	12 (300)	25.50 (648)	13.50 (343)	95 (43)

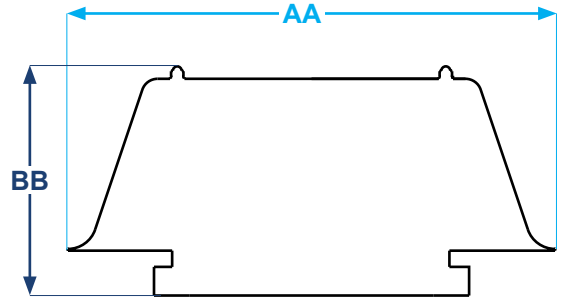
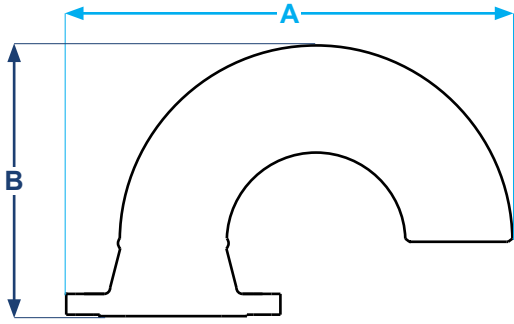

MODEL 5000 FLOW CAPACITY

Air Flow - 1000 Standard Cubic Feet per Hour at 60°F

Tank Pressure		Size In (mm)						
InWC	oz/in ²	2 (50)	3 (80)	4 (100)	6 (150)	8 (200)	10 (250)	12 (300)
1	0.58	3.34	7.34	12.7	28.6	49.6	78.2	112
2	1.16	4.72	10.4	17.9	40.5	70.2	111	159
3	1.73	5.78	12.7	21.9	49.5	85.9	135	194
4	2.31	6.67	14.7	25.3	57.2	99.2	156	224
6	3.47	8.17	18.0	31.0	70.0	121	192	275
8	4.62	9.44	20.8	35.8	80.9	140	221	317
10	5.78	10.5	23.2	40.0	90.4	157	247	354
15	8.66	12.9	28.4	48.9	111	192	303	434
20	11.6	14.9	32.8	56.5	128	221	349	501
25	14.4	16.7	36.6	63.1	143	248	390	560
30	17.3	18.2	40.1	69.1	156	271	427	613
35	20.2	19.7	43.3	74.6	169	293	461	662
40	23.1	21.0	46.3	79.7	180	313	493	707
45	26.0	22.3	49.1	84.5	191	332	523	750
50	28.9	23.5	51.7	89.1	201	349	551	790
55	31.8	24.6	54.2	93.4	211	366	577	828
60	34.7	25.7	56.6	97.5	220	382	603	864

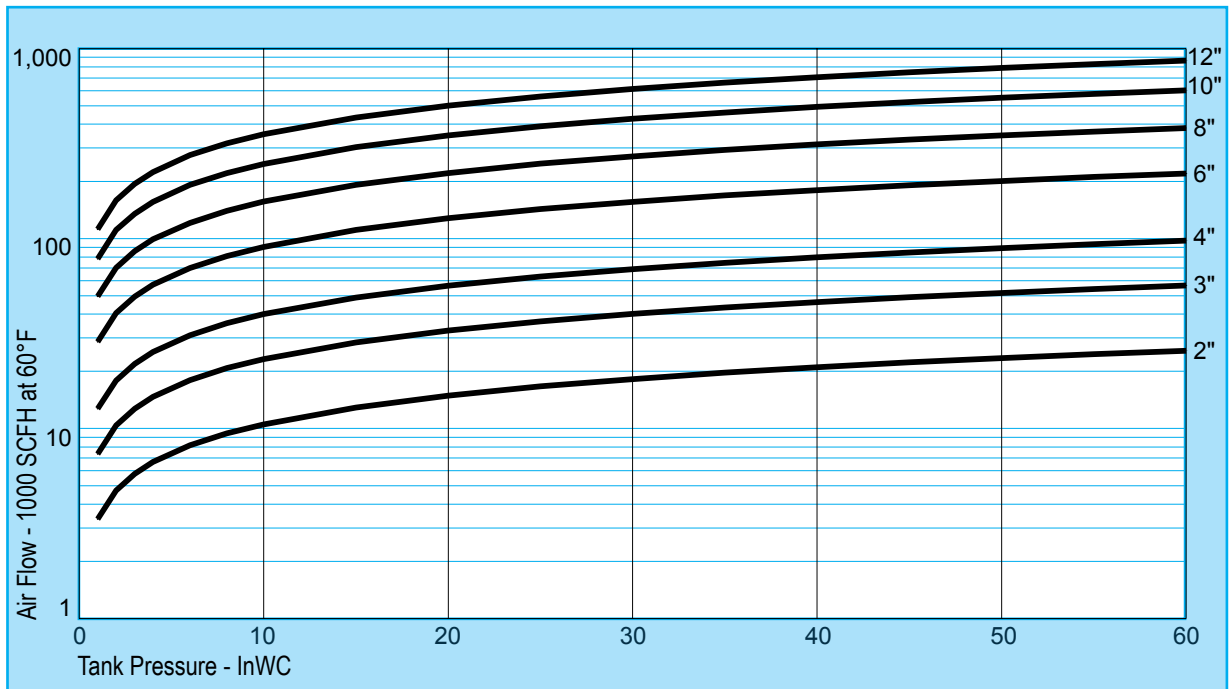

MODEL 5000 FLOW CAPACITY

Air Flow - 1000 Normal Cubic Meters per Hour at 0°C

Tank Pressure		Size In (mm)						
mmWC	mb	2 (50)	3 (80)	4 (100)	6 (150)	8 (200)	10 (250)	12 (300)
25	2.45	0.09	0.21	0.36	0.80	1.39	2.20	3.15
50	4.90	0.13	0.29	0.50	1.14	1.97	3.11	4.46
75	7.35	0.16	0.36	0.62	1.39	2.41	3.81	5.46
100	9.80	0.19	0.41	0.71	1.61	2.79	4.40	6.30
150	14.7	0.23	0.51	0.87	1.97	3.41	5.38	7.72
200	19.6	0.27	0.58	1.01	2.27	3.94	6.21	8.91
250	24.5	0.30	0.65	1.12	2.54	4.41	6.95	9.96
375	36.8	0.36	0.80	1.38	3.11	5.39	8.50	12.2
500	49.0	0.42	0.92	1.59	3.59	6.23	9.81	14.1
625	61.3	0.47	1.03	1.77	4.01	6.96	11.0	15.7
750	73.5	0.51	1.13	1.94	4.39	7.62	12.0	17.2
875	85.8	0.55	1.22	2.10	4.74	8.22	13.0	18.6
1000	98.0	0.59	1.30	2.24	5.07	8.79	13.9	19.9
1125	110	0.63	1.38	2.38	5.37	9.32	14.7	21.1
1250	123	0.66	1.45	2.50	5.66	9.82	15.5	22.2
1375	135	0.69	1.52	2.62	5.94	10.3	16.2	23.3
1500	147	0.72	1.59	2.74	6.20	10.7	16.9	24.3

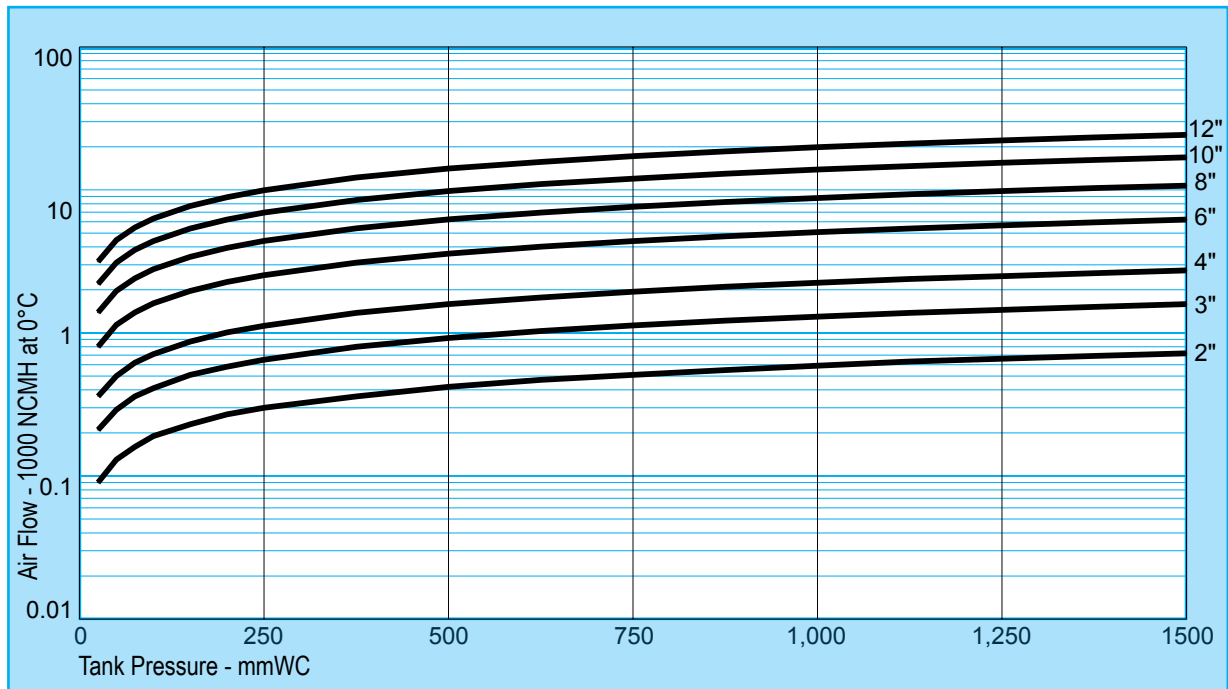

MODEL 5000 FLOW CAPACITY

Air Flow - 1000 Standard Cubic Feet per Hour at 60°F

Tank Vacuum		Size In (mm)						
InWC	oz/in ²	2 (50)	3 (80)	4 (100)	6 (150)	8 (200)	10 (250)	12 (300)
1	0.58	2.78	6.11	10.5	23.8	41.3	65.1	93.4
2	1.16	3.92	8.63	14.9	33.6	58.3	91.9	132
3	1.73	4.80	10.6	18.2	41.1	71.3	112	161
4	2.31	5.53	12.2	21.0	47.4	82.3	130	186
6	3.47	6.76	14.9	25.6	57.9	100	158	227
8	4.62	7.79	17.1	29.5	66.7	116	182	262
10	5.78	8.68	19.1	32.9	74.4	129	203	292
15	8.66	10.6	23.2	40.0	90.5	157	247	355
20	11.6	12.1	26.6	45.9	104	180	284	407
25	14.4	13.4	29.6	51.0	115	200	315	452
30	17.3	14.6	32.2	55.4	125	217	343	491
35	20.2	15.7	34.5	59.4	134	233	367	527
40	23.1	16.6	36.6	63.1	143	247	390	559
45	26.0	17.5	38.5	66.4	150	260	411	589
50	28.9	18.3	40.3	69.5	157	272	430	616
55	31.8	19.1	42.0	72.3	164	284	447	641
60	34.7	19.8	43.5	75.0	169	294	463	665

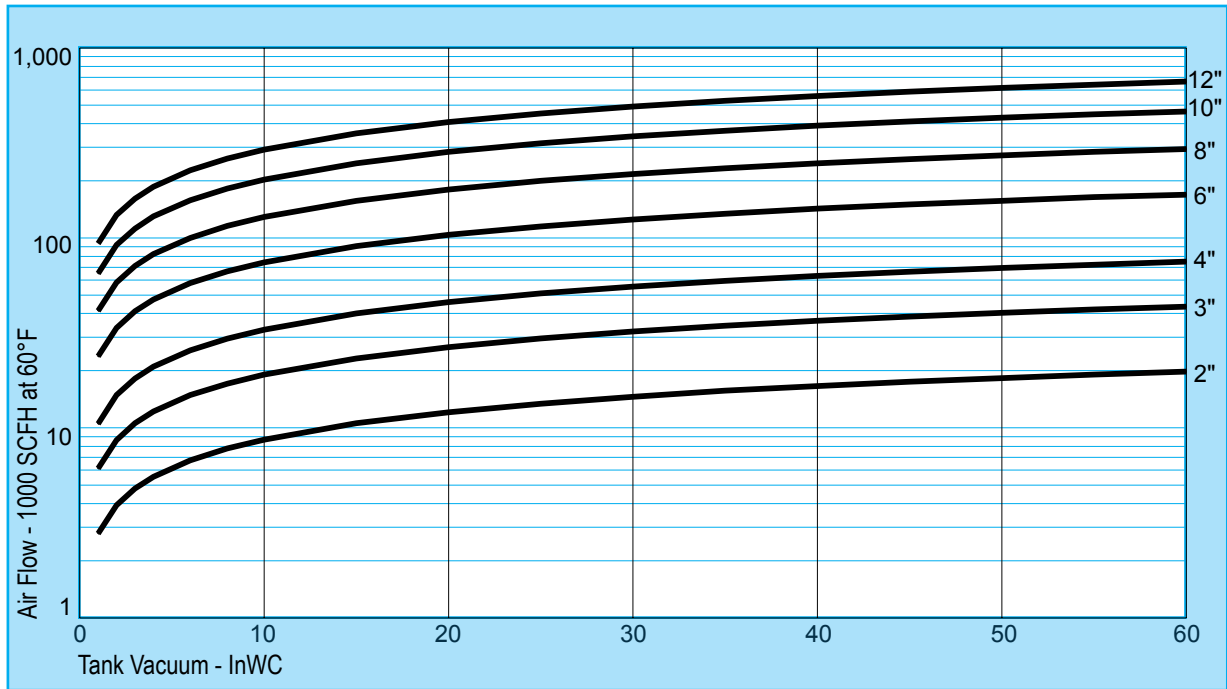

MODEL 5000 FLOW CAPACITY

Air Flow - 1000 Normal Cubic Meters per Hour at 0°C

Tank Vacuum		Size In (mm)						
mmWC	mb	2 (50)	3 (80)	4 (100)	6 (150)	8 (200)	10 (250)	12 (300)
25	2.5	0.08	0.17	0.30	0.67	1.2	1.8	2.6
50	4.9	0.11	0.24	0.42	0.95	1.6	2.6	3.7
75	7.4	0.13	0.30	0.51	1.16	2.0	3.2	4.5
100	9.8	0.16	0.34	0.59	1.33	2.3	3.6	5.2
150	14.7	0.19	0.42	0.72	1.63	2.8	4.5	6.4
200	19.6	0.22	0.48	0.83	1.88	3.3	5.1	7.4
250	24.5	0.24	0.54	0.92	2.09	3.6	5.7	8.2
375	36.8	0.30	0.65	1.13	2.54	4.4	7.0	10.0
500	49.0	0.34	0.75	1.29	2.92	5.1	8.0	11.4
625	61.3	0.38	0.83	1.43	3.24	5.6	8.9	12.7
750	73.5	0.41	0.90	1.56	3.52	6.1	9.6	13.8
875	85.8	0.44	0.97	1.67	3.78	6.6	10.3	14.8
1000	98.0	0.47	1.03	1.77	4.01	7.0	11.0	15.7
1125	110	0.49	1.08	1.87	4.23	7.3	11.6	16.6
1250	123	0.52	1.13	1.96	4.42	7.7	12.1	17.3
1375	135	0.54	1.18	2.04	4.60	8.0	12.6	18.0
1500	147	0.56	1.22	2.11	4.77	8.3	13.0	18.7

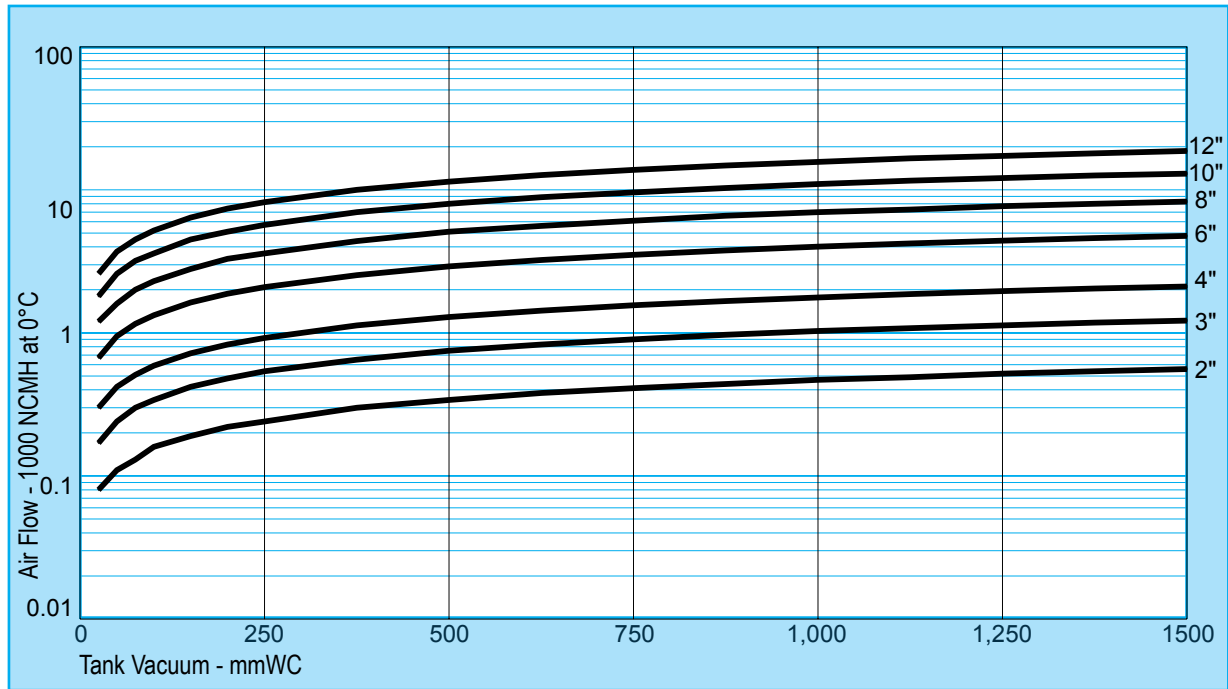

MODEL 5100 FLOW CAPACITY

Air Flow - 1000 Standard Cubic Feet per Hour at 60°F

Tank Pressure		Size In (mm)						
InWC	oz/in ²	2 (50)	3 (80)	4 (100)	6 (150)	8 (200)	10 (250)	12 (300)
1	0.58	3.78	8.32	14.3	32.4	56.2	88.6	127
2	1.16	5.35	11.8	20.3	45.8	79.5	125	180
3	1.73	6.55	14.4	24.8	56.1	97.4	154	220
4	2.31	7.56	16.6	28.7	64.8	112	177	254
6	3.47	9.26	20.4	35.1	79.4	138	217	311
8	4.62	10.7	23.5	40.5	91.7	159	251	359
10	5.78	12.0	26.3	45.3	102	178	280	402
15	8.66	14.6	32.2	55.5	125	217	343	492
20	11.6	16.9	37.2	64.0	145	251	396	568
25	14.4	18.9	41.5	71.5	162	281	442	634
30	17.3	20.7	45.5	78.3	177	307	484	695
35	20.2	22.3	49.1	84.6	191	332	523	750
40	23.1	23.8	52.4	90.4	204	354	559	801
45	26.0	25.3	55.6	95.8	217	376	592	850
50	28.9	26.6	58.6	101	228	396	624	895
55	31.8	27.9	61.4	106	239	415	654	938
60	34.7	29.2	64.1	110	250	433	683	980

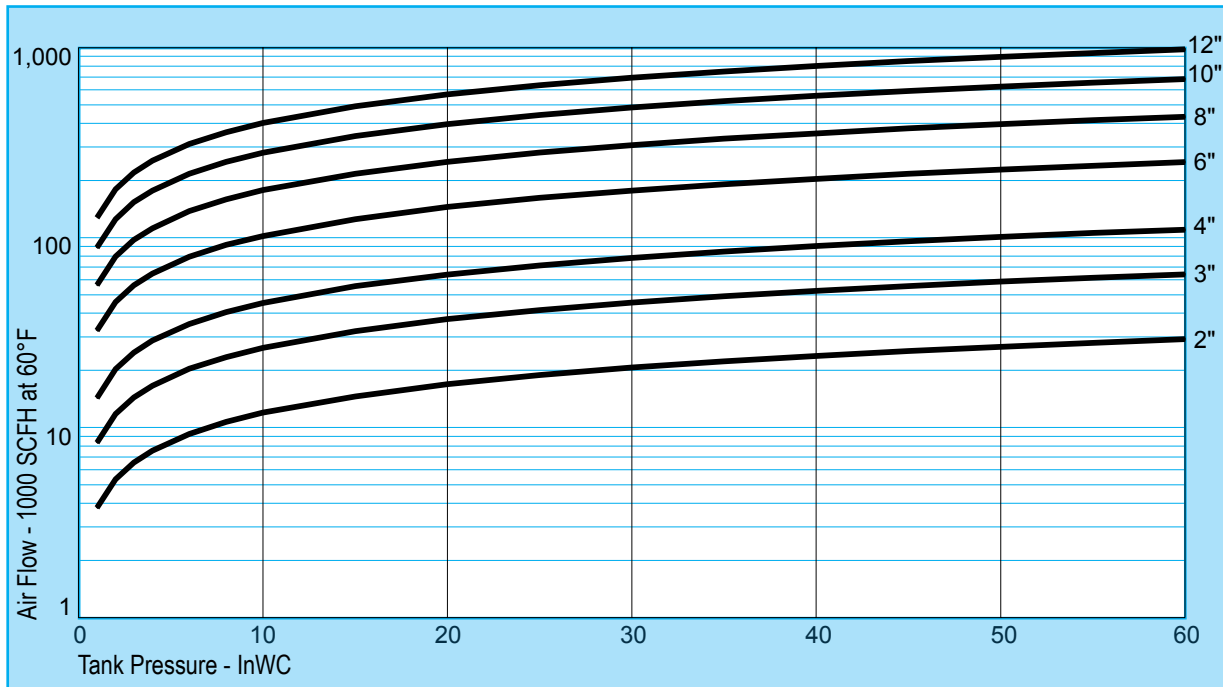

MODEL 5100 FLOW CAPACITY

Air Flow - 1000 Normal Cubic Meters per Hour at 0°C

Tank Pressure		Size In (mm)						
mmWC	mb	2 (50)	3 (80)	4 (100)	6 (150)	8 (200)	10 (250)	12 (300)
25	2.45	0.11	0.23	0.40	0.91	1.58	2.49	3.57
50	4.90	0.15	0.33	0.57	1.29	2.23	3.52	5.05
75	7.35	0.18	0.41	0.70	1.58	2.74	4.31	6.19
100	9.80	0.21	0.47	0.81	1.82	3.16	4.98	7.14
150	14.7	0.26	0.57	0.99	2.23	3.87	6.10	8.75
200	19.6	0.30	0.66	1.14	2.58	4.47	7.04	10.1
250	24.5	0.34	0.74	1.27	2.88	4.99	7.87	11.3
375	36.8	0.41	0.90	1.56	3.53	6.11	9.64	13.8
500	49.0	0.47	1.04	1.80	4.07	7.06	11.1	16.0
625	61.3	0.53	1.17	2.01	4.55	7.88	12.4	17.8
750	73.5	0.58	1.28	2.20	4.98	8.63	13.6	19.5
875	85.8	0.63	1.38	2.38	5.38	9.32	14.7	21.1
1000	98.0	0.67	1.47	2.54	5.74	10.0	15.7	22.5
1125	110	0.71	1.56	2.69	6.09	10.6	16.6	23.9
1250	123	0.75	1.65	2.84	6.42	11.1	17.5	25.2
1375	135	0.78	1.73	2.97	6.73	11.7	18.4	26.4
1500	147	0.82	1.80	3.11	7.02	12.2	19.2	27.5

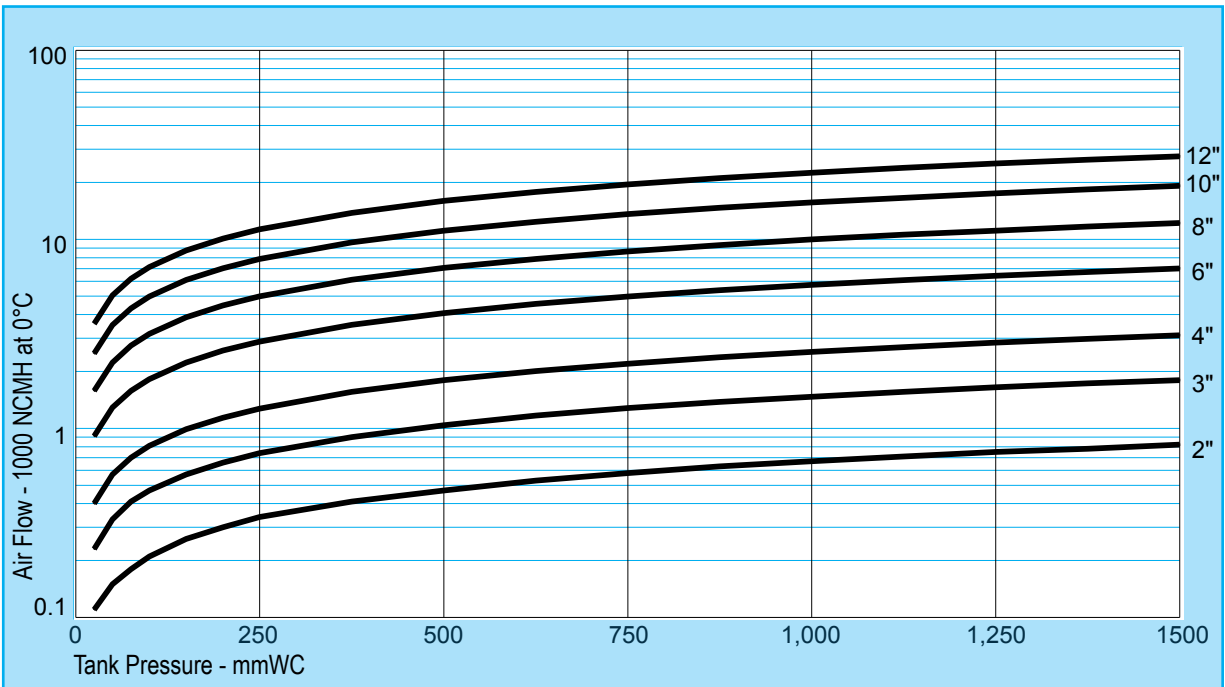

MODEL 5100 FLOW CAPACITY

Air Flow - 1000 Standard Cubic Feet per Hour at 60°F

Tank Vacuum		Size In (mm)						
InWC	oz/in ²	2 (50)	3 (80)	4 (100)	6 (150)	8 (200)	10 (250)	12 (300)
1	0.58	3.06	6.72	11.6	26.2	45.4	71.6	103
2	1.16	4.32	9.49	16.4	37.0	64.1	101	145
3	1.73	5.28	11.6	20.0	45.2	78.5	124	177
4	2.31	6.09	13.4	23.1	52.2	90.5	143	205
6	3.47	7.44	16.4	28.2	63.7	111	174	250
8	4.62	8.56	18.8	32.5	73.4	127	201	288
10	5.78	9.55	21.0	36.2	81.8	142	224	321
15	8.66	11.6	25.5	44.0	99.6	173	272	390
20	11.6	13.3	29.3	50.5	114	198	312	448
25	14.4	14.8	32.5	56.1	127	220	347	497
30	17.3	16.1	35.4	61.0	138	239	377	541
35	20.2	17.3	37.9	65.4	148	256	404	580
40	23.1	18.3	40.3	69.4	157	272	429	615
45	26.0	19.3	42.4	73.1	165	286	452	648
50	28.9	20.2	44.4	76.4	173	300	473	678
55	31.8	21.0	46.2	79.6	180	312	492	705
60	34.7	21.8	47.8	82.5	186	323	510	731

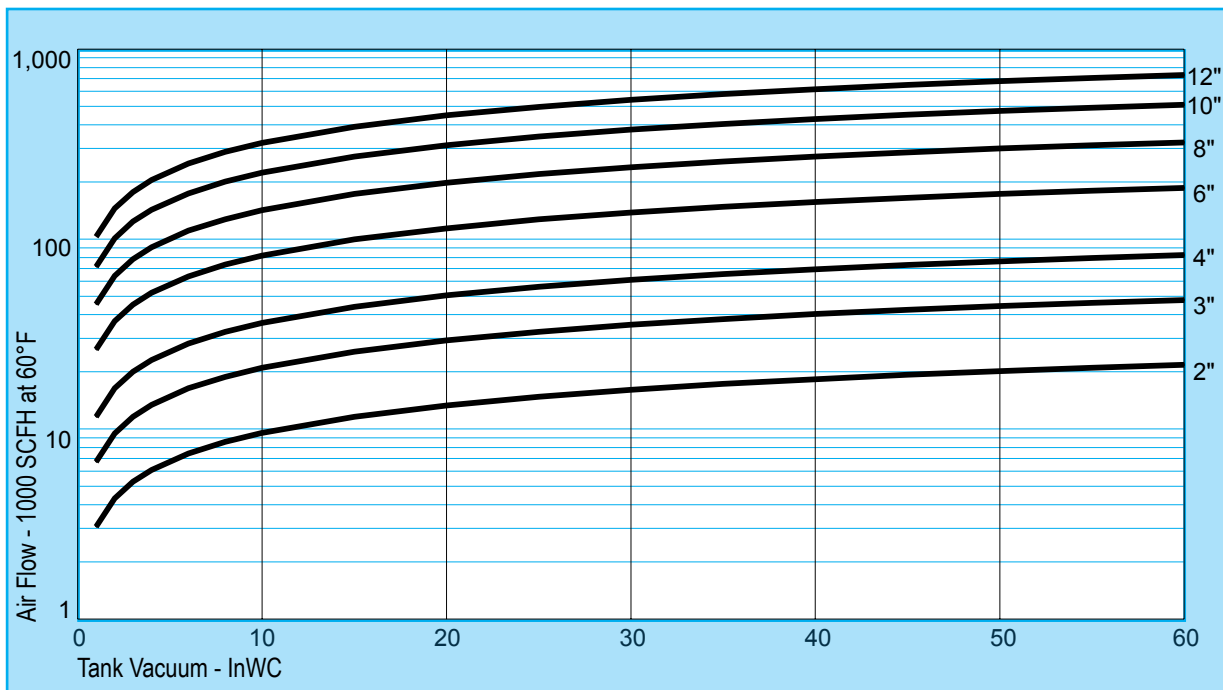

MODEL 5100 FLOW CAPACITY

Air Flow - 1000 Normal Cubic Meters per Hour at 0°C

Tank Vacuum		Size In (mm)						
mmWC	mb	2 (50)	3 (80)	4 (100)	6 (150)	8 (200)	10 (250)	12 (300)
25	2.45	0.09	0.19	0.33	0.74	1.28	2.01	2.89
50	4.90	0.12	0.27	0.46	1.04	1.80	2.84	4.08
75	7.35	0.15	0.33	0.56	1.27	2.21	3.48	4.99
100	9.80	0.17	0.38	0.65	1.47	2.54	4.01	5.75
150	14.7	0.21	0.46	0.79	1.79	3.11	4.90	7.02
200	19.6	0.24	0.53	0.91	2.06	3.58	5.64	8.09
250	24.5	0.27	0.59	1.02	2.30	3.99	6.29	9.02
375	36.8	0.33	0.72	1.24	2.80	4.85	7.65	11.0
500	49.0	0.37	0.82	1.42	3.21	5.57	8.78	12.6
625	61.3	0.42	0.91	1.58	3.56	6.18	9.74	14.0
750	73.5	0.45	1.00	1.71	3.88	6.72	10.6	15.2
875	85.8	0.49	1.07	1.84	4.16	7.21	11.4	16.3
1000	98.0	0.52	1.13	1.95	4.41	7.65	12.1	17.3
1125	110	0.54	1.19	2.06	4.65	8.06	12.7	18.2
1250	123	0.57	1.25	2.15	4.86	8.43	13.3	19.1
1375	135	0.59	1.30	2.24	5.06	8.78	13.8	19.9
1500	147	0.61	1.35	2.32	5.25	9.10	14.3	20.6

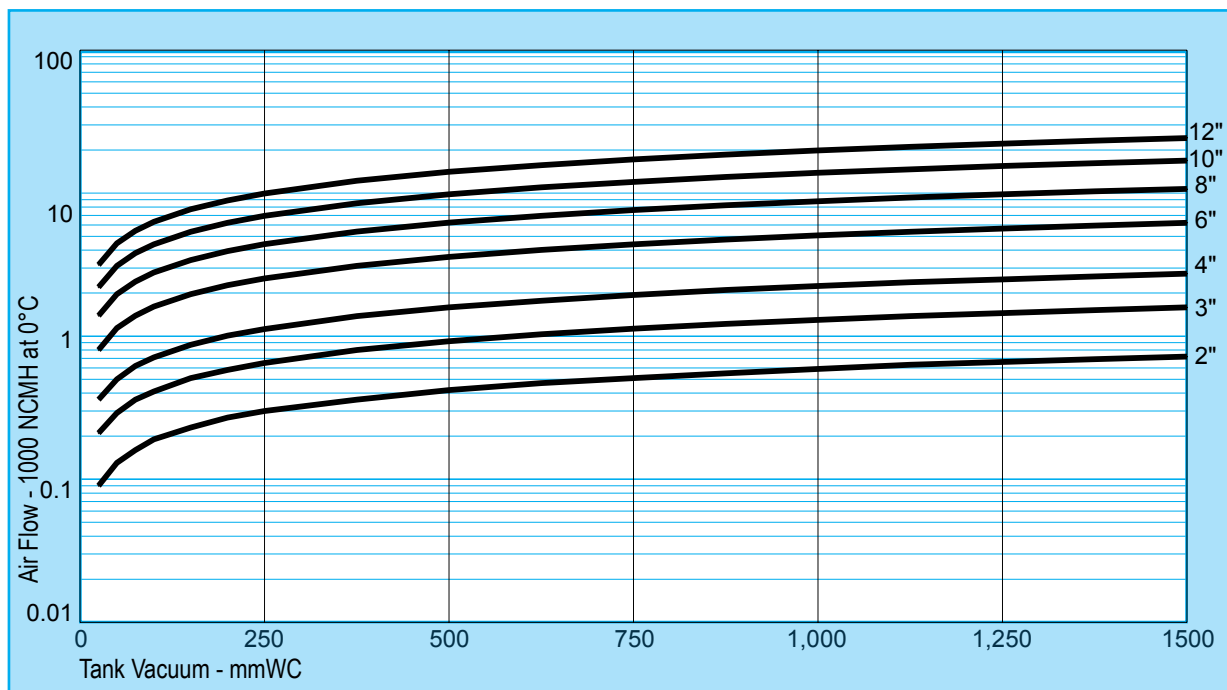

HOW TO ORDER

For easy ordering, select proper model numbers

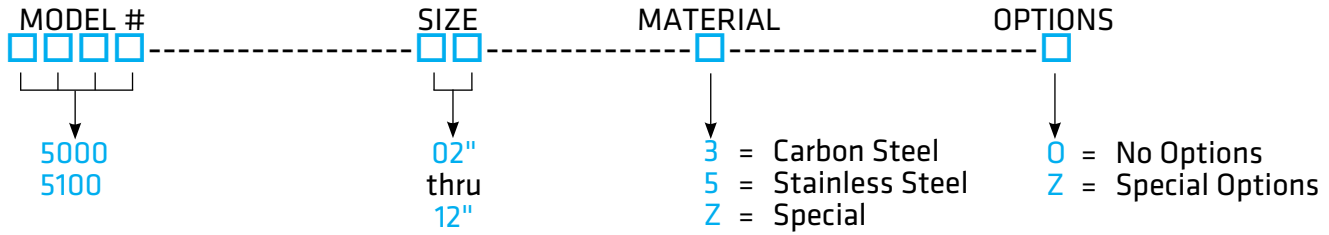

Notes

- Include model number and setting when ordering.
- For special options, consult factory.

Example



Indicates a 2" Model 5000 with Carbon Steel Body and no other options.



GROTHCORP.COM